

# Bridgelux LED Arrays

## Product Data Sheet

### Introduction

The Bridgelux family of LED Array products delivers high performance, compact and cost-effective solid-state lighting solutions to serve the general lighting market. These products combine the higher efficiency, lifetime, and reliability benefits of LEDs with the light output levels of many conventional lighting sources.

Product options are tailored to match light output levels of conventional light sources, delivering between 400 and 2000 lumens under application conditions in cool, neutral and warm white colors. In order to satisfy system design requirements, the Bridgelux LED Arrays are specified to deliver these values hot, or under assumed typical use conditions, eliminating the need of incorporating additional sources to account for thermal degradation.

Various configurations are available allowing the product to be optimized on efficacy, CRI, light output, cost, or a combination of these attributes. These high lumen output integrated sources reduce system design complexity, enabling miniaturized cost-effective lamp and luminaire designs. Typical applications include task, accent, spot, track, down light, wide area and security lighting.

### Features

- Compact high flux density light source
- Uniform high quality illumination
- Streamlined thermal path
- Energy Star / ANSI compliant binning structure
- More energy efficient than incandescent, halogen and some fluorescent lamps
- Low voltage DC operation
- Instant light with unlimited dimming
- Long operating life
- RoHS compliant and Pb free

### Benefits

- Enhanced optical control
- Clean white light
- Significantly reduced thermal resistance and increased operating temperatures
- Uniform consistent white light
- Lower operating costs
- Increased safety
- Easy to use with daylight and motion detectors to enable increased energy savings
- Reduced maintenance costs
- Environmentally friendly, no disposal issues



---

Table of Contents	Page
Product Nomenclature	3
Average Lumen Maintenance Characteristics	3
Environmental Compliance	3
Minor Product Change Policy	4
Cautionary Statements	4
Case Temperature Measurement Point	4
Flux Characteristics	5
Optical Characteristics	6
Electrical Characteristics	7
Absolute Minimum and Maximum Ratings	8
Mechanical Dimensions	9
Typical Radiation Pattern	11
Wavelength Characteristics	12
Typical Relative Luminous Flux vs. Current	14
Typical Light Output Characteristics Over Temperature	16
Typical Chromaticity Characteristics Over Temperature	17
Typical Forward Current Characteristics	18
Current Derating Curves	21
Product Binning	26
Luminous Flux Binning Information	26
Color Binning Information	27
Mechanical Assembly and Handling	30
Product Packaging and Labeling	31
Packaging Tube Design	33

---

## Product Nomenclature

The part number designation for Bridgelux LED Arrays is explained as follows:

B X R A – A B C D E – 0 0 0 0 0

Where:

B X R A – designates product family

A – designates color, C for Cool White, N for Neutral White, and W for Warm White

B C – designates array product flux, 04 for a 400 lumen array, 08 for a 800 lumen array, 12 for a 1200 lumen array, and 20 for a 2000 lumen array

D E – reserved for future product designations

0 0 0 0 0 – designates the standard product option, reserved for future product designations

The base product part number (BXRA-ABCDE) is indicated on each individual unit, printed on the bottom of the array.

## Average Lumen Maintenance Characteristics

Bridgelux projects that its family of LED Array products will deliver, on average, greater than 70% lumen maintenance after 50,000 hours of operation at the rated forward test current. This performance assumes constant current operation with case temperature maintained at or below 70°C. For use beyond these typical operating conditions please consult your Bridgelux sales representative for further assistance.

These projections are based on a combination of package test data, semiconductor chip reliability data, a fundamental understanding of package related degradation mechanisms, and performance observed from products installed in the field using Bridgelux die technology. Bridgelux conducts lumen maintenance tests per LM80. Observation of design limits is required in order to achieve this projected lumen maintenance.

## Environmental Compliance

Bridgelux is committed to providing environmentally friendly products to the solid-state lighting market. Bridgelux LED Arrays are compliant to the European Union directives on the restriction of hazardous substances in electronic equipment, namely the RoHS directive. Bridgelux will not intentionally add the following restricted materials to array products: lead, mercury, cadmium, hexavalent chromium, polybrominated biphenyls (PBB) or polybrominated diphenyl ethers (PBDE).

---

## Minor Product Change Policy

The rigorous qualification testing on products offered by Bridgelux provides performance assurance. Slight cosmetic changes that do not affect form, fit, or function may occur as Bridgelux continues product optimization.

### CAUTION: CONTACT WITH OPTICAL AREA

Contact with the resin area should be avoided. Applying stress to the resin area can result in damage to the product.

### CAUTION: EYE SAFETY

Eye safety classification for the use of Bridgelux LED Arrays is contained in the CIE S 009/E2002 Photobiological Safety of Lamps and Lamp Systems specification. Bridgelux LED Arrays are classified under section 6 lamp classification as Risk Group 2 (Moderate Risk). Please use appropriate precautions. It is important that employees working with LEDs are trained to use them safely. Luminaire manufacturers should refer to CIE S 009/E2002 to establish the classification of their product.

### CAUTION: RISK OF BURN

Do not touch the LED Array or resin area during operation. Allow the LED Array to cool for a sufficient period of time before handling. The LED Array may reach elevated temperatures such that it can burn skin when touched.

## Case Temperature Measurement Point

A case temperature measurement point location is included on the top surface of the Bridgelux LED Arrays. The location of this measurement point is indicated in the mechanical dimensions section of this data sheet.

The purpose of this measurement point is to allow the user access to a measurement point closely linked to the true case temperature on the back surface of the LED array. Once the LED array is installed, it is challenging to measure the back surface of the array, or true case temperature. Measuring the top surface of the product can lead to inaccurate results due to the poor thermal conductivity of the top layers of the array such as the solder mask and other materials.

Bridgelux has provided the case temperature measurement location in a manner which closely ties it to the true case temperature of the array under steady state operation. Deviations between thermal measurements taken at the point indicated and the back of the LED array differ by less than 1°C, providing a robust method to testing thermal operation once the product is installed.

## Flux Characteristics

Table 1: Flux Characteristics

Color	Base Part Number	Typical Luminous Flux $\phi_v$ (lm), $T_{case}=60^{\circ}C$ <sup>[3]</sup>	Minimum Luminous Flux $\phi_v$ (lm), $T_j=25^{\circ}C$ <sup>[1]</sup>	Typical Luminous Flux $\phi_v$ (lm), $T_j=25^{\circ}C$	Test Current (mA) <sup>[2]</sup>
Warm White	BXRA-W0400	400	400	440	900
	BXRA-W0800	800	800	880	1300
	BXRA-W1200	1200	1200	1320	1600
Neutral White	BXRA-N0400	400	400	440	800
	BXRA-N0800	800	800	880	1200
	BXRA-N1200	1200	1200	1320	1400
Cool White	BXRA-C0400	400	400	440	600
	BXRA-C0800	800	800	880	900
	BXRA-C1200	1200	1200	1320	1300
	BXRA-C2000	2000	2000	2200	1750

### Notes for Table 1:

1. Bridgelux maintains a  $\pm 7\%$  tolerance of flux measurements.
2. Parts are tested in pulsed conditions,  $T_j = 25^{\circ}C$ . Pulse width is 10 ms at rated test current.
3. Typical performance when driven with direct current using Bridgelux test set-up. Please contact a Bridgelux sales representative for additional details.

## Optical Characteristics

Table 2: Optical Characteristics

Color	Base Part Number	Color Temperature (CCT) <sup>[1],[2],[3]</sup>			Typical Color Rendering Index <sup>[4]</sup>	Typical Viewing Angle (Degrees) $2\theta_{\frac{1}{2}}$ <sup>[6]</sup>	Typical Center Beam Candle Power (cd) <sup>[5]</sup>
		Min	Typ	Max			
Warm White	BXRA-W0400	2850 K	3000 K	3700 K	82	120	140
	BXRA-W0800					120	280
	BXRA-W1200					120	382
Neutral White	BXRA-N0400	3700 K	4100 K	4750 K	80	120	140
	BXRA-N0800					120	280
	BXRA-N1200					120	382
Cool White	BXRA-C0400	4750 K	5600 K	7000 K	65	120	140
	BXRA-C0800					120	280
	BXRA-C1200					120	382
	BXRA-C2000					120	636

Notes for Table 2:

1. Parts are tested in pulsed conditions,  $T_j = 25^\circ\text{C}$ . Pulse width is 10 ms at rated test current.
2. Refer to Flux Characteristic Table for test current data.
3. Product is binned for color in x y coordinates.
4. Higher CRI options available upon request.
5. Center beam candle power is a calculated value based on lambertian radiation pattern.
6. Viewing angle is the off axis angle from the centerline where  $I_v$  is  $\frac{1}{2}$  of the peak value.

## Electrical Characteristics

Table 3: Electrical Characteristics

Color	Base Part Number	Forward Voltage $V_f$ (V) <sup>[1]</sup>			Typical Temperature Coefficient of Forward Voltage (mV/°C) $\Delta V_f/\Delta T_j$	Typical Thermal Resistance Junction to Case (°C/W) $R\theta_{j-c}$	Test Current (mA) <sup>[2]</sup>
		Min.	Typ.	Max.			
Warm White	BXRA-W0400	9.0	9.8	10.6	-3 to -9	1.0	900
	BXRA-W0800	12.0	13.2	14.3	-4 to -12	0.7	1300
	BXRA-W1200	15.0	16.4	17.8	-5 to -15	0.5	1600
Neutral White	BXRA-N0400	9.0	9.7	10.5	-3 to -9	1.0	800
	BXRA-N0800	12.0	13.0	14.1	-4 to -12	0.7	1200
	BXRA-N1200	15.0	16.2	17.5	-5 to -15	0.5	1400
Cool White	BXRA-C0400	9.0	9.8	10.6	-3 to -9	1.4	600
	BXRA-C0800	12.0	13.0	14.1	-4 to -12	0.8	900
	BXRA-C1200	12.0	13.2	14.3	-4 to -12	0.7	1300
	BXRA-C2000	15.0	16.6	18.0	-5 to -15	0.5	1750

Notes for Table 3:

1. Electrical characteristics at test current specified in Flux Characteristics Table,  $T_j = 25^\circ\text{C}$ .
2. Bridgelux maintains a tester tolerance of  $\pm 0.10$  V on forward voltage measurements.

## Absolute Minimum and Maximum Ratings

Table 4: Minimum and Maximum Current and Reverse Voltage Ratings

Part Number	Maximum DC Forward Current (mA)	Minimum DC Forward Current (mA) <sup>[2]</sup>	Maximum Peak Pulsed Current (mA)	Maximum Reverse Voltage (Vr) <sup>[1]</sup>
BXRA-W0400	1500	450	2100	-15 Volts
BXRA-W0800	2000	600	2800	-20 Volts
BXRA-W1200	2500	750	3500	-25 Volts
BXRA-N0400	1500	450	2100	-15 Volts
BXRA-N0800	2000	600	2800	-20 Volts
BXRA-N1200	2500	750	3500	-25 Volts
BXRA-C0400	1000	300	1400	-15 Volts
BXRA-C0800	1500	450	2100	-20 Volts
BXRA-C1200	2000	600	2800	-20 Volts
BXRA-C2000	2500	750	3500	-25 Volts

Table 5: Maximum Ratings

Parameter	Maximum Rating
ESD Sensitivity	8,000 V Human Body Model (HBM) Class 2, JESD22-A114-B 400 V Machine Model (MM) Class 2 JESD22-A115-B
LED Junction Temperature	150°C
Storage Temperature	-40°C to +105°C
Operating Case Temperature	105°C
Soldering Temperature	3.5 seconds, 350°C or lower

Notes for Table 4:

1. Light emitting diodes are not designed to be driven in reverse voltage.
2. Driving these high current devices at low currents can result in variations in performance. For low current operation pulse width modulation is recommended.



## Mechanical Dimensions

Figure 1: Drawing for 400 lumen product options (part numbers BXRA-C0400, BXRA-N0400 and BXRA-W0400).

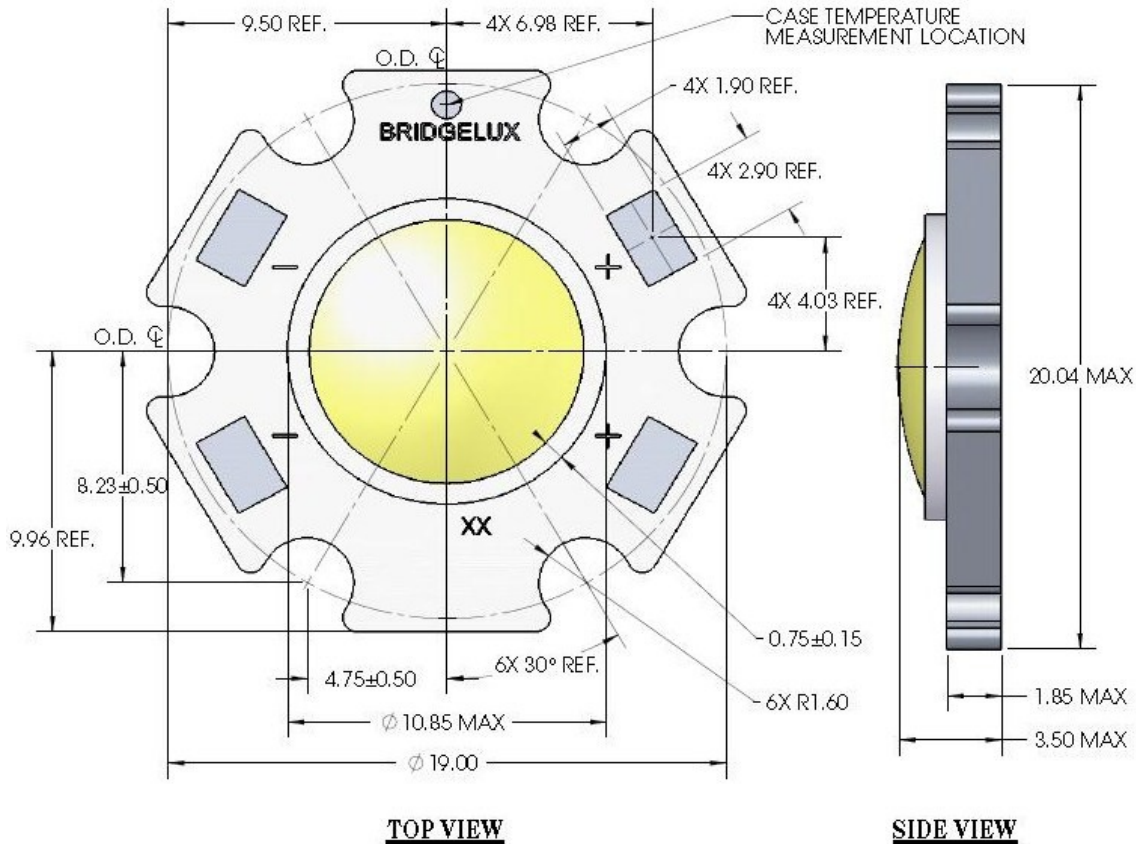

### Notes for Figure 1:

1. Slots are for M2.5 or #4 screws.
2. Solder pads are labeled "+" and "-" to denote positive and negative, respectively.
3. Drawings are not to scale.
4. Drawing dimensions are in millimeters.
5. Bridgelux recommends two tapped holes for mounting screws with  $19.20 \pm 0.05$ mm center-to-center spacing.
6. Avoid contact of the optical area to prevent damage to the product. The resin area can get quite hot under operating conditions and should not be touched.
7. Unless otherwise specified, tolerances are  $\pm 0.10$ mm.
8. Dimensions with REF are for reference only.
9. Refer to product Application Notes AN10 and AN11 for product handling, mounting and heat sink recommendations.

## Mechanical Dimensions (continued)

Figure 2: Drawing for 800, 1200, and 2000 lumen product options (part numbers BXRA-C0800, BXRA-N0800, BXRA-W0800, BXRA-C1200, BXRA-N1200, BXRA-W1200 and BXRA-C2000).

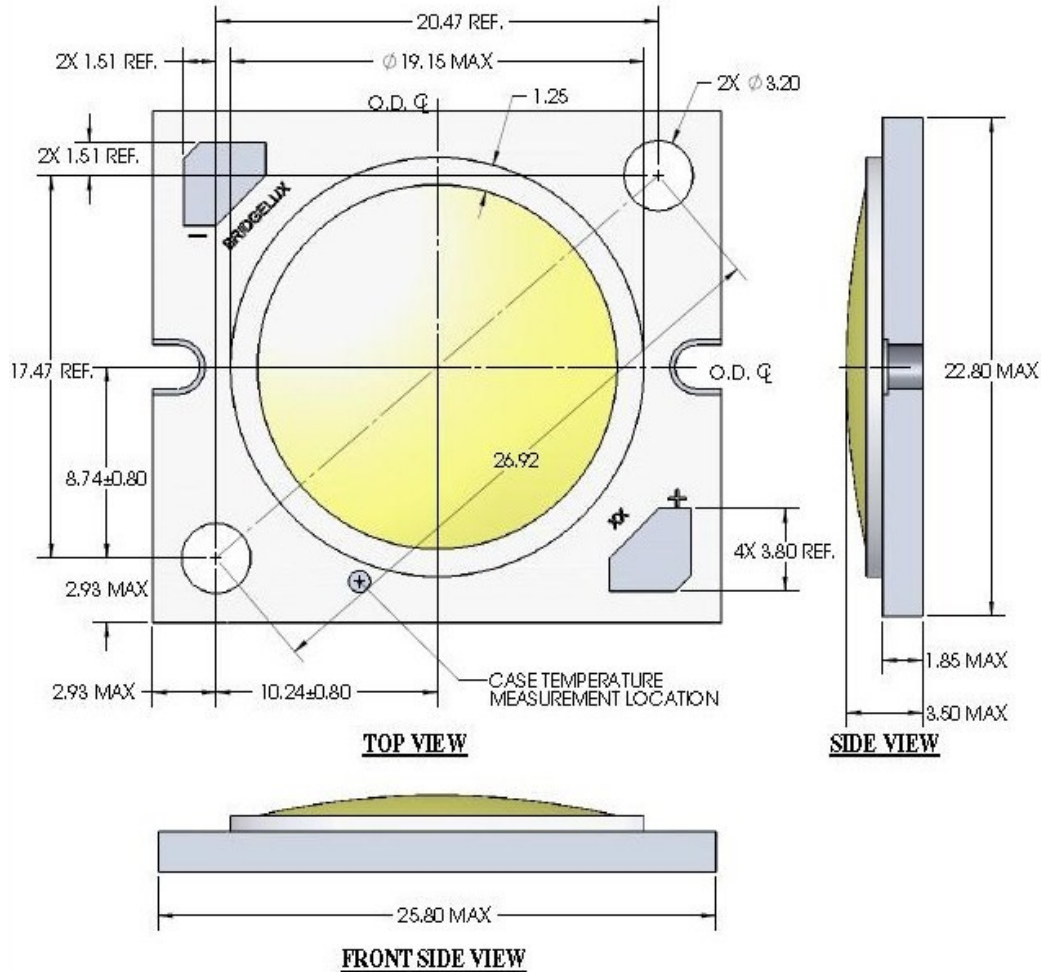

### Notes for Figure 2:

1. Mounting holes are for M2.5 or #4 screws.
2. Solder pads are labeled "+" and "-" to denote positive and negative, respectively.
3. Drawings are not to scale.
4. Drawing dimensions are in millimeters.
5. Bridgelux recommends two tapped holes for mounting screws with  $26.92 \pm 0.10$ mm center-to-center spacing.
6. Avoid contact of the optical area to prevent damage to the product. The resin area can get quite hot under operating conditions and should not be touched.
7. Unless otherwise specified, tolerances are  $\pm 0.10$ mm.
8. Dimensions with REF are for reference only.
9. Refer to product Application Notes AN10 and AN11 for product handling, mounting and heat sink recommendations.

## Typical Radiation Pattern

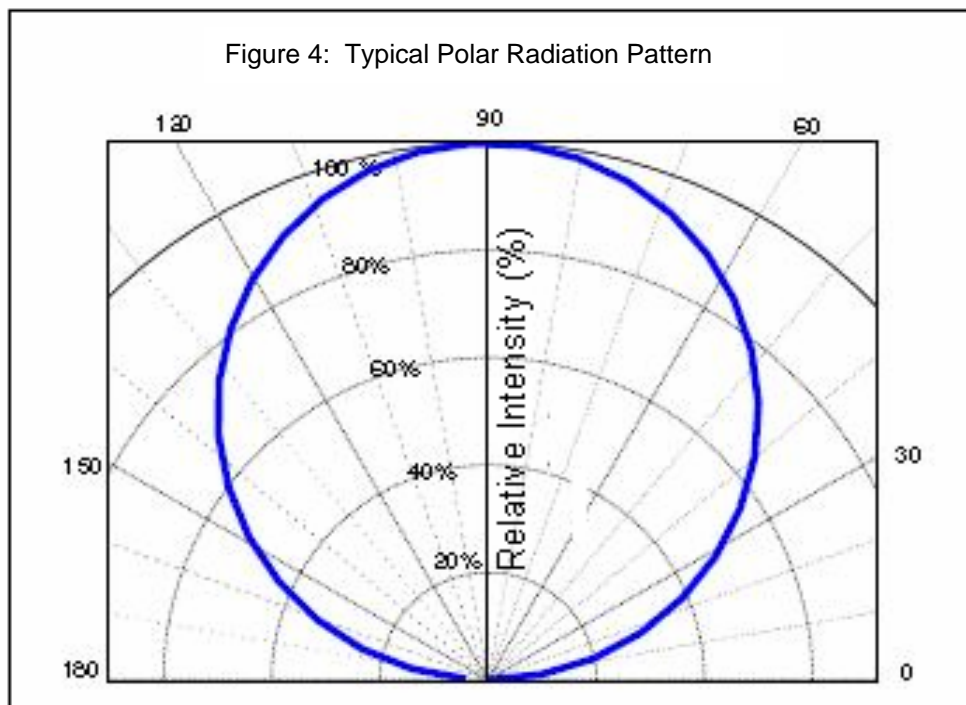
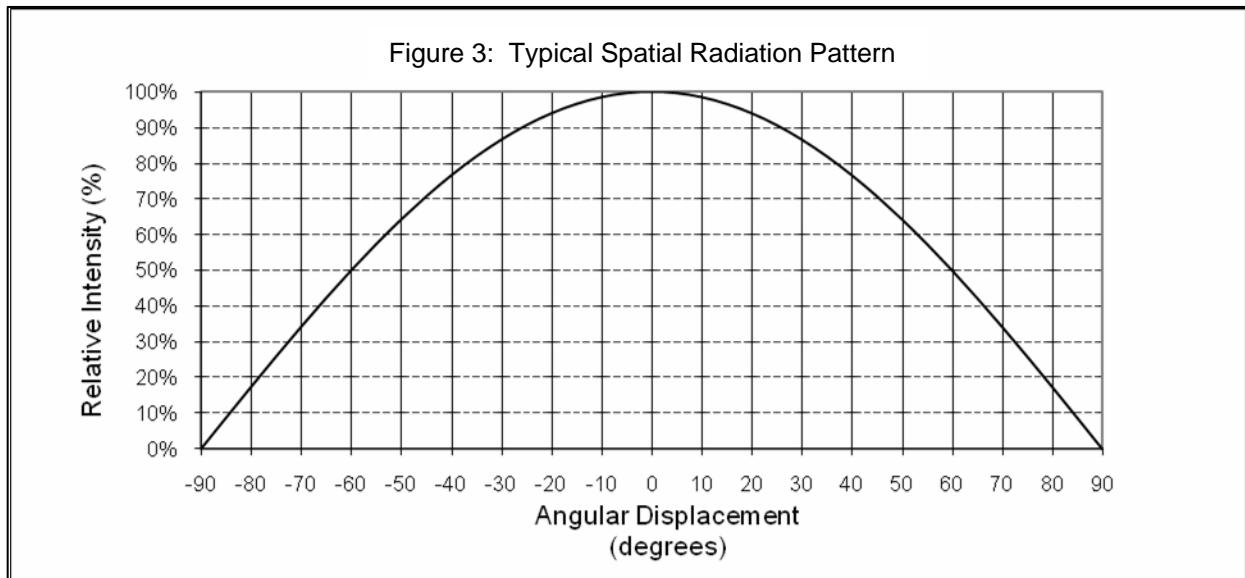

Wavelength Characteristics at Rated Test Current,  $T_j=25^\circ\text{C}$

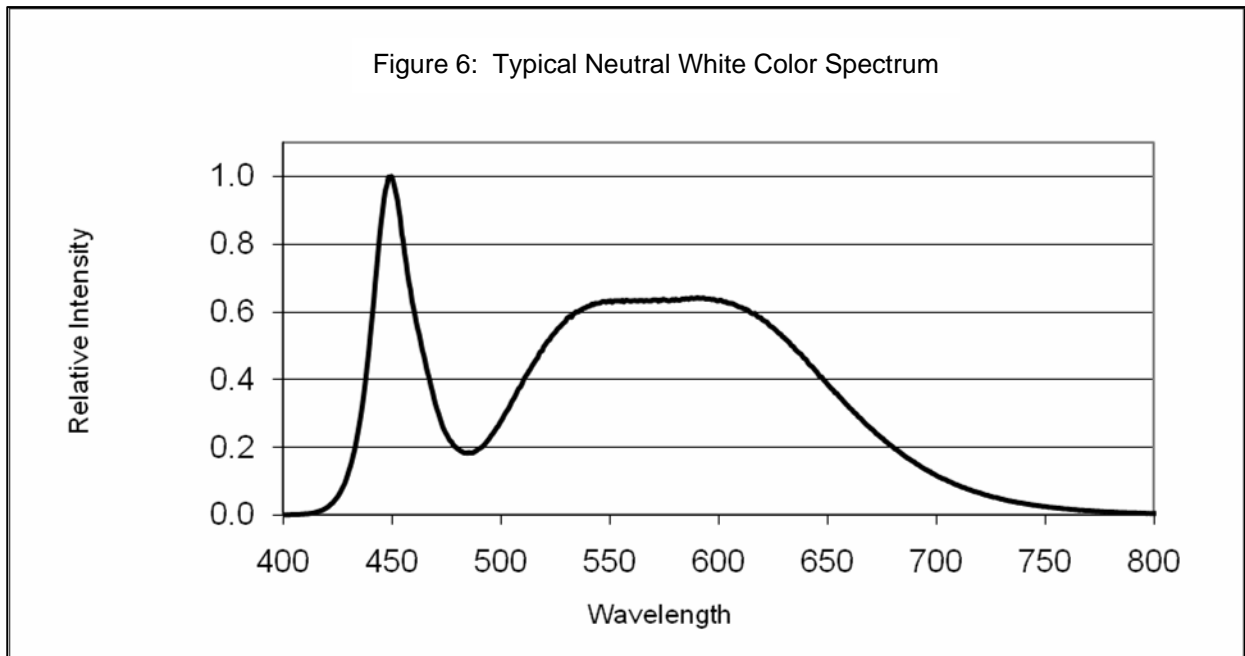
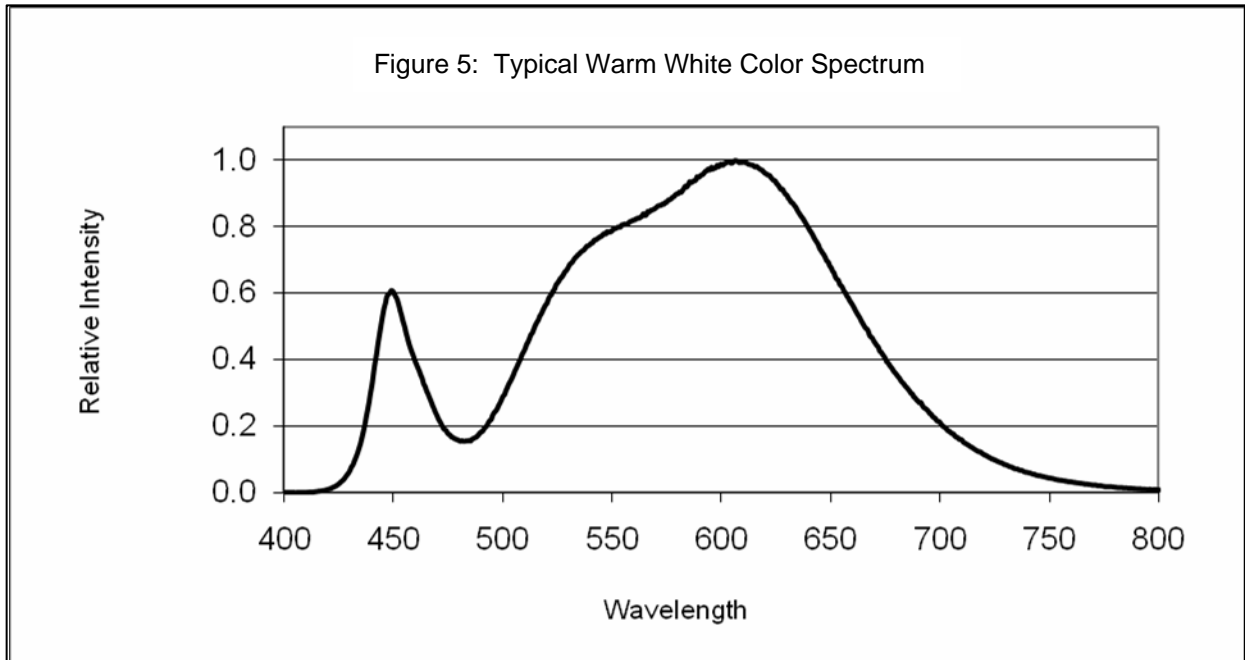

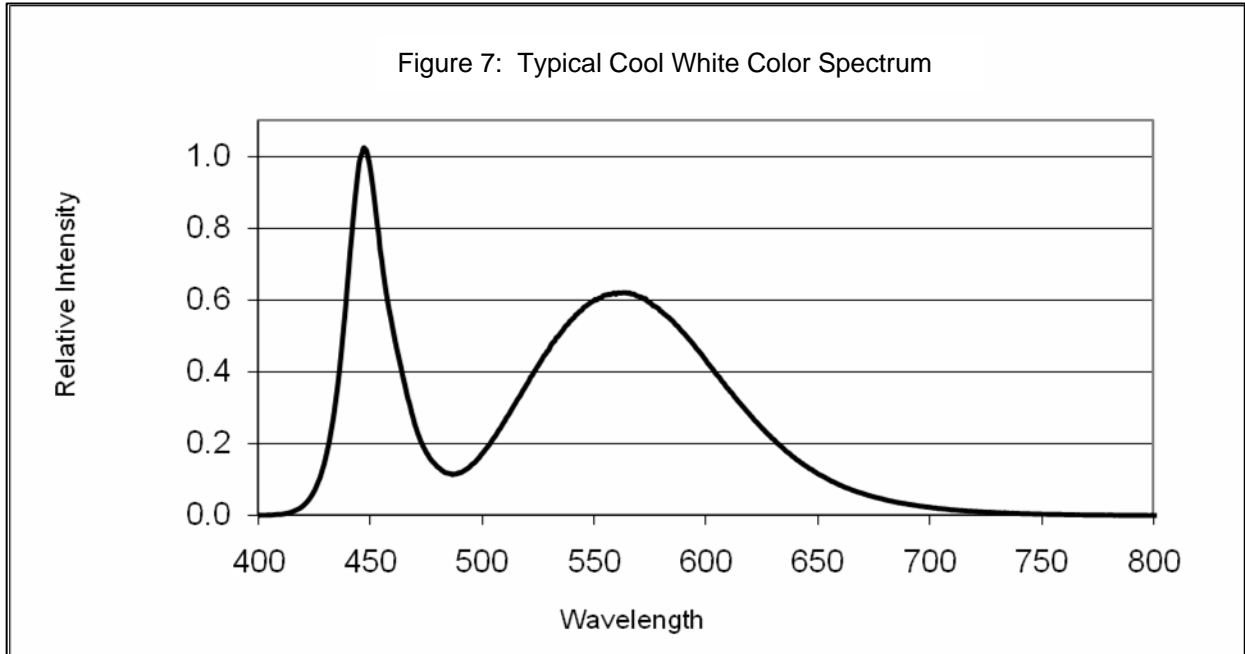

Typical Relative Luminous Flux vs. Current,  $T_j=25^\circ\text{C}$

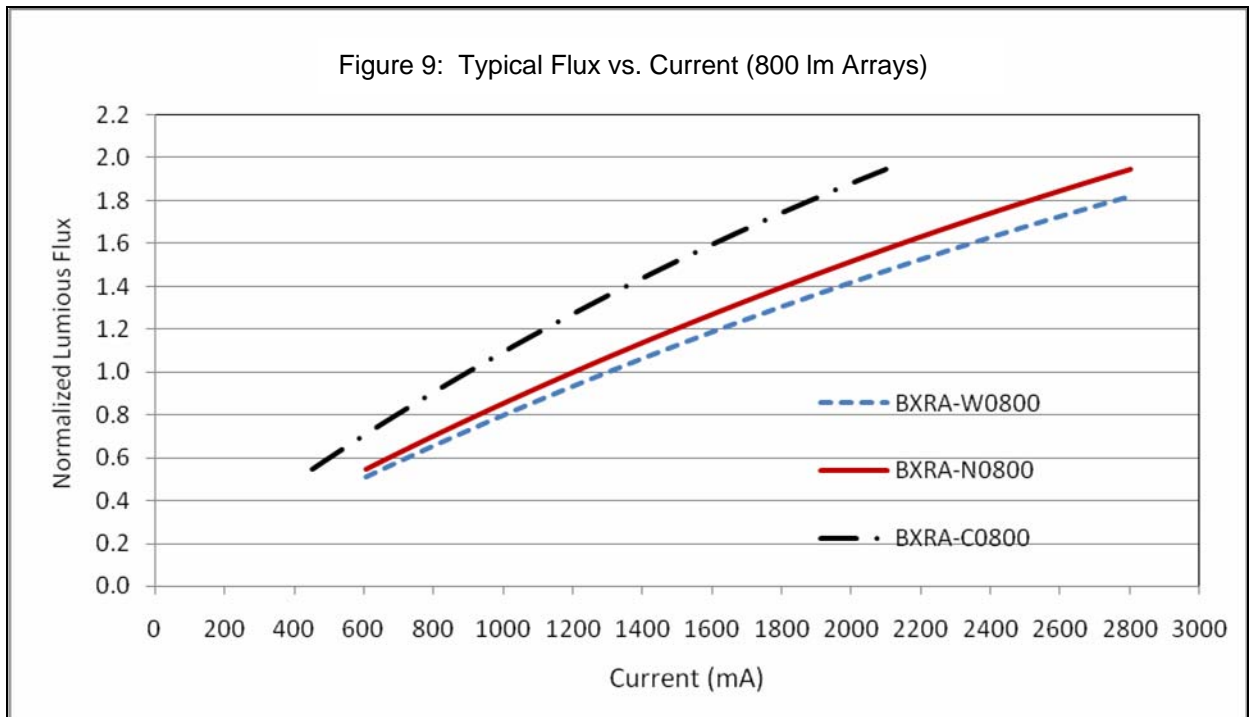
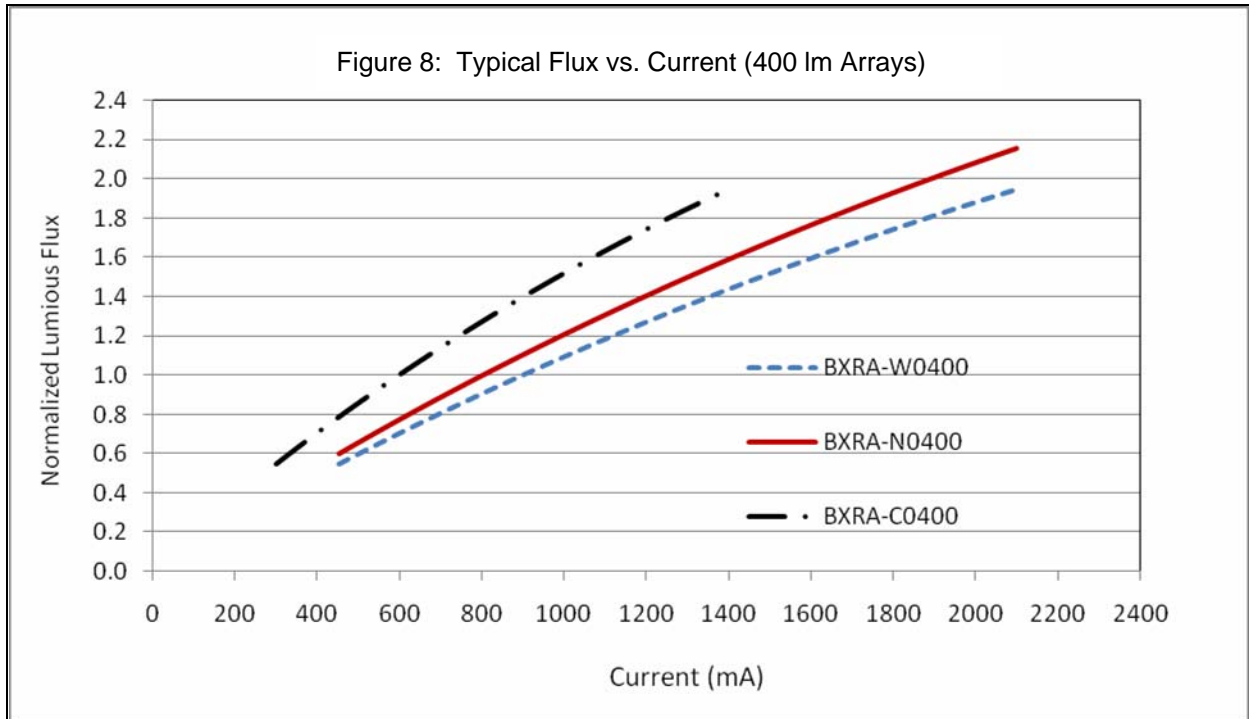

Typical Relative Luminous Flux vs. Current,  $T_j=25^\circ\text{C}$  (continued)

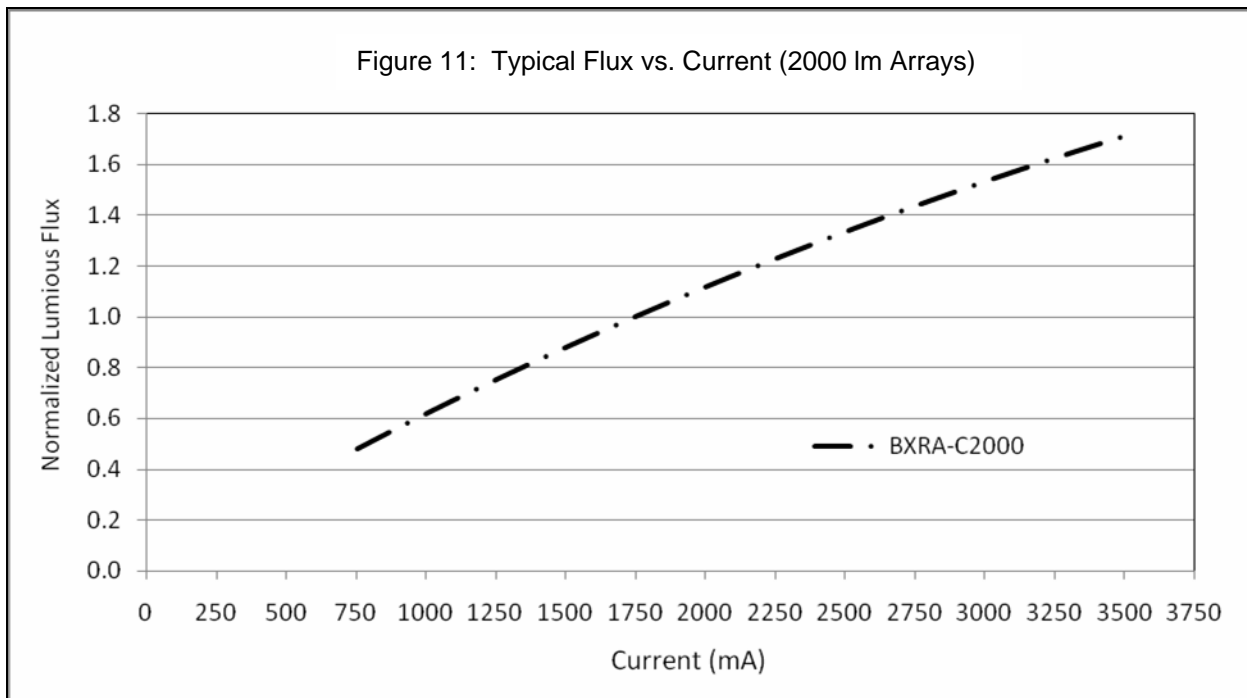
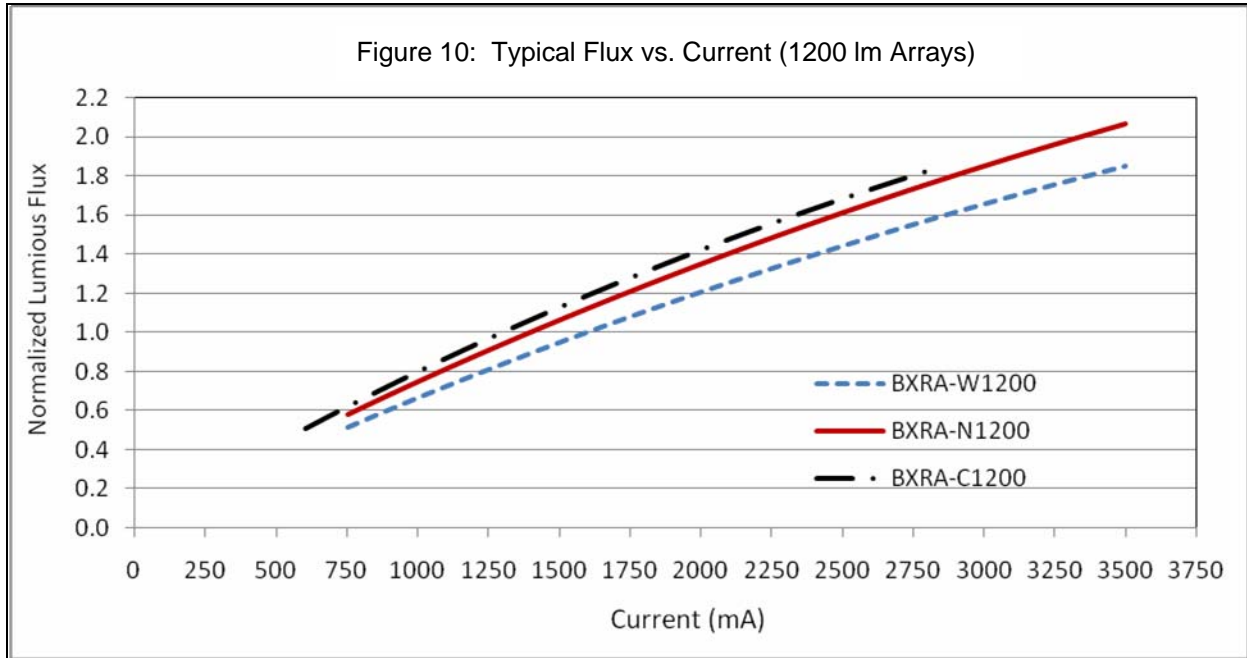

Note for Figures 8, 9, 10 and 11: Bridgelux does not recommend driving high power array devices at low currents. Doing so may produce unpredictable results. Pulse width modulation (PWM) is recommended for dimming effects.

## Typical Light Output Characteristics vs. Temperature

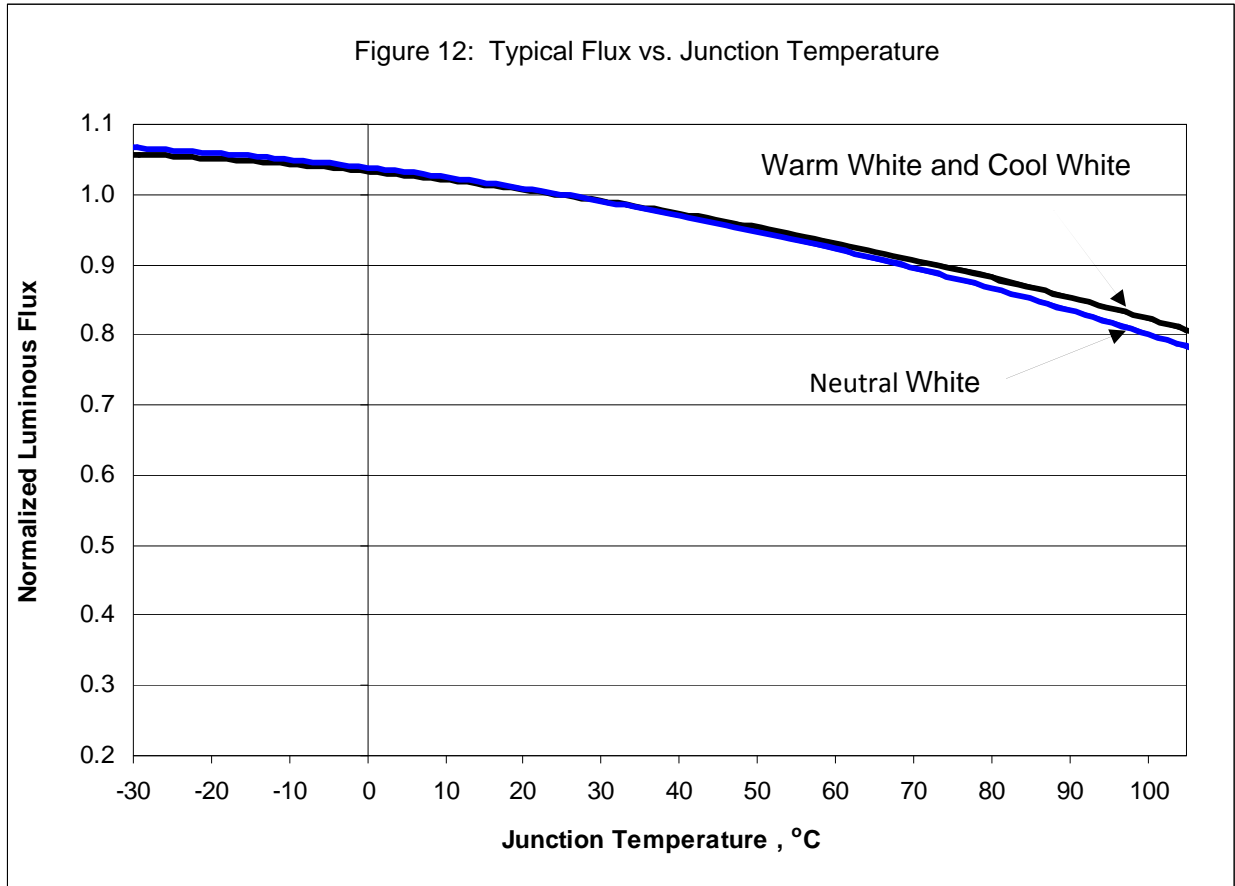



Typical Chromaticity Characteristics vs. Temperature

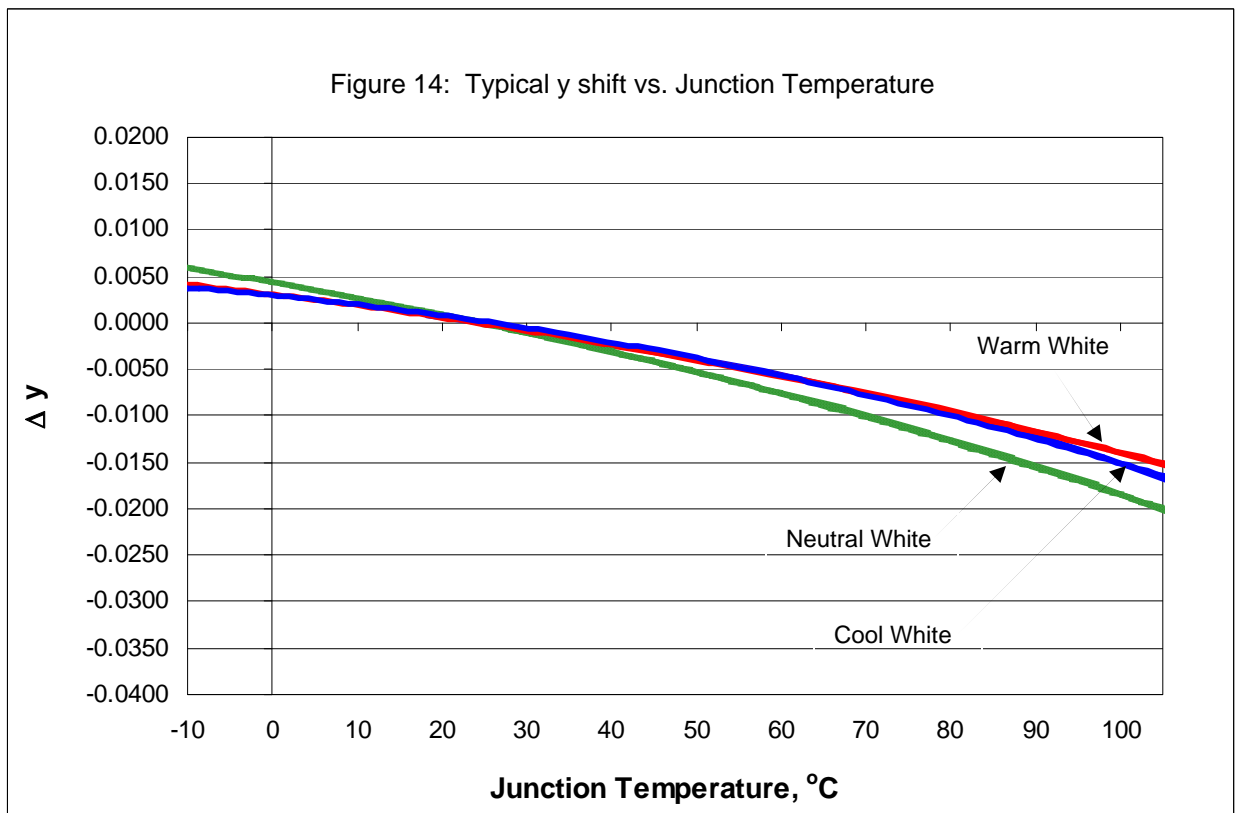
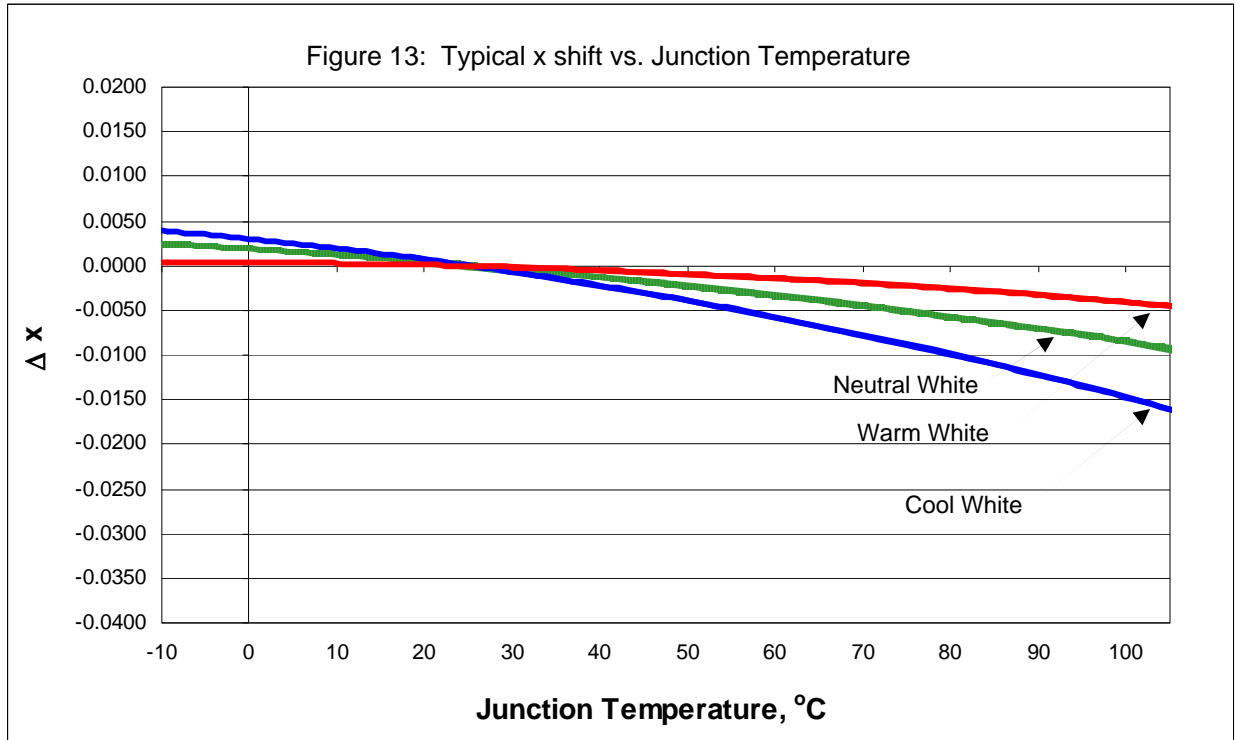

Typical Forward Current Characteristics at  $T_j = 25^\circ\text{C}$

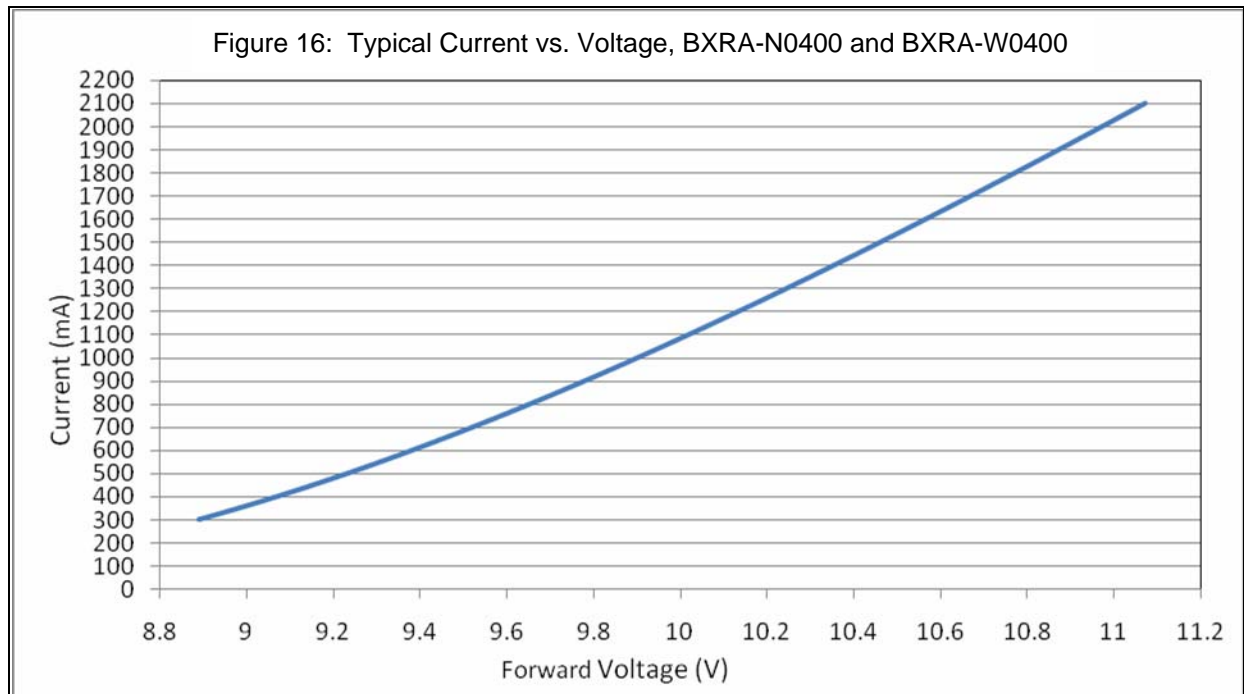
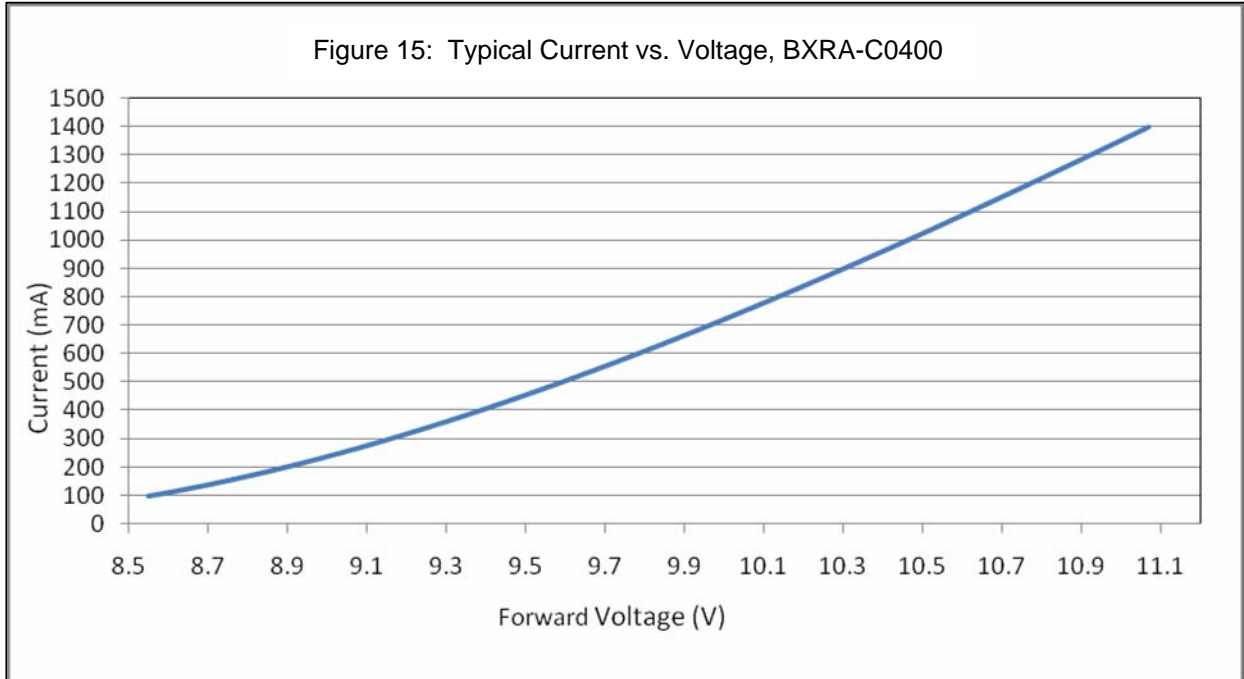

Typical Forward Current Characteristics at  $T_j = 25^\circ\text{C}$  (continued)

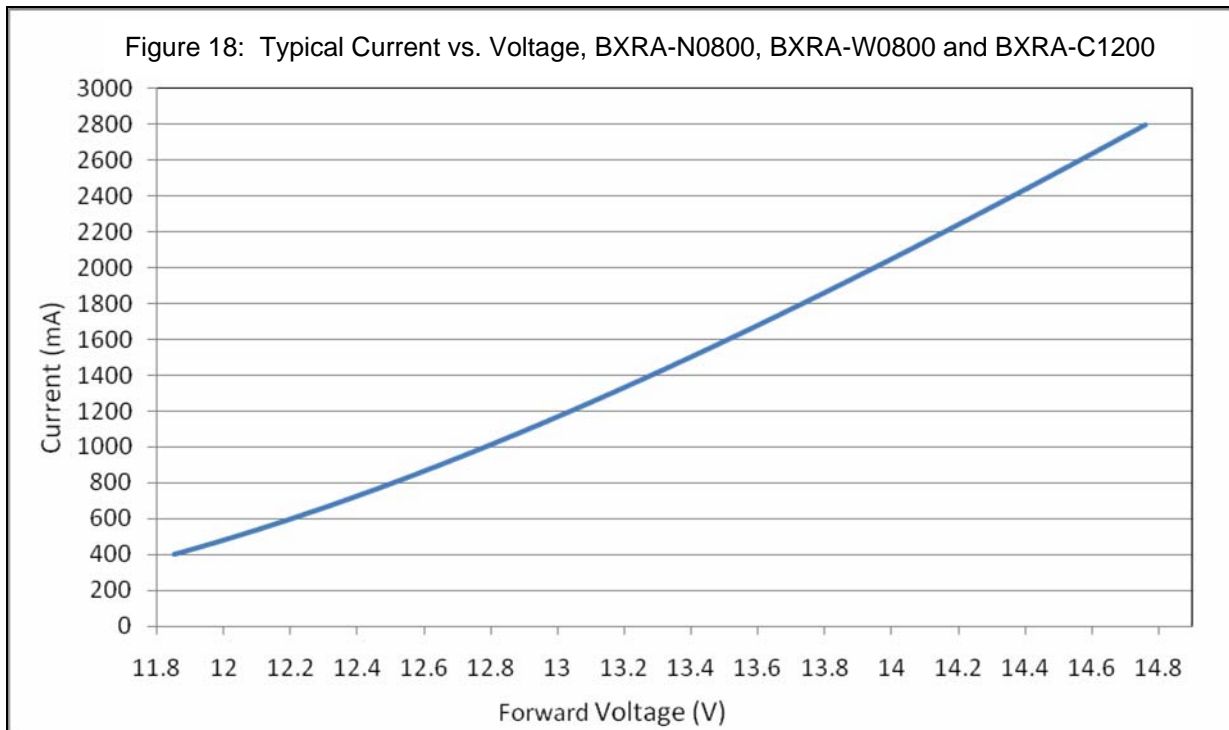
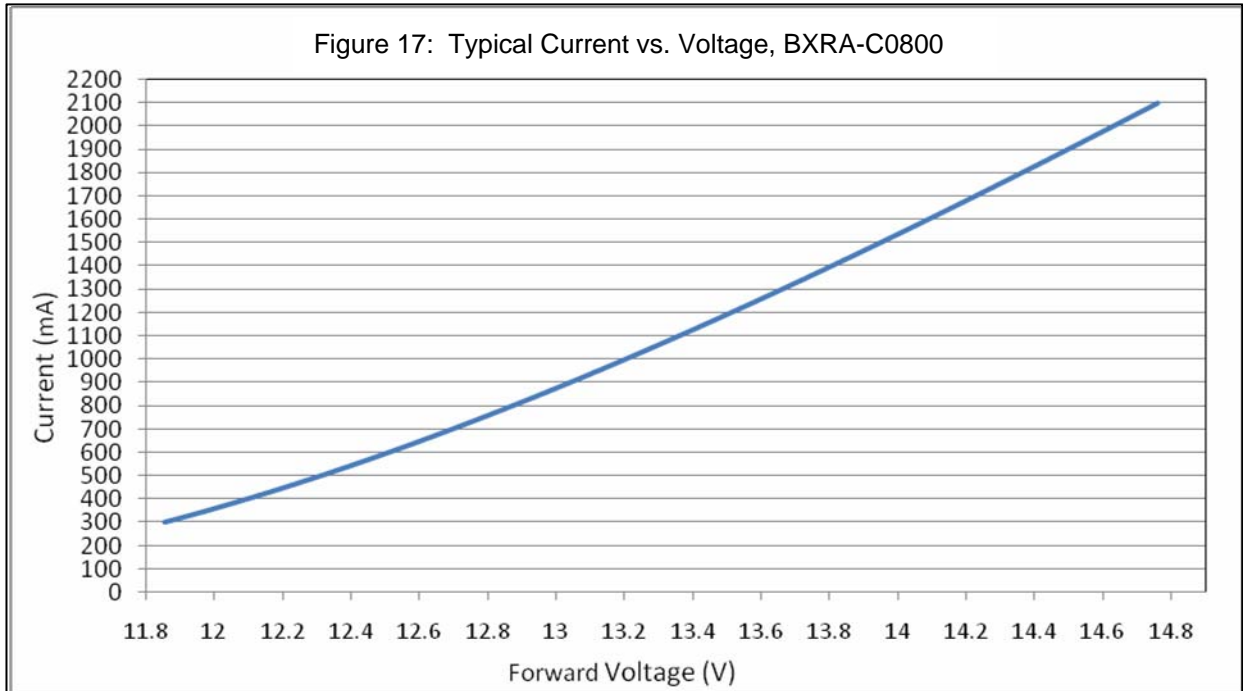

Typical Forward Current Characteristics at  $T_j = 25^\circ\text{C}$  (continued)

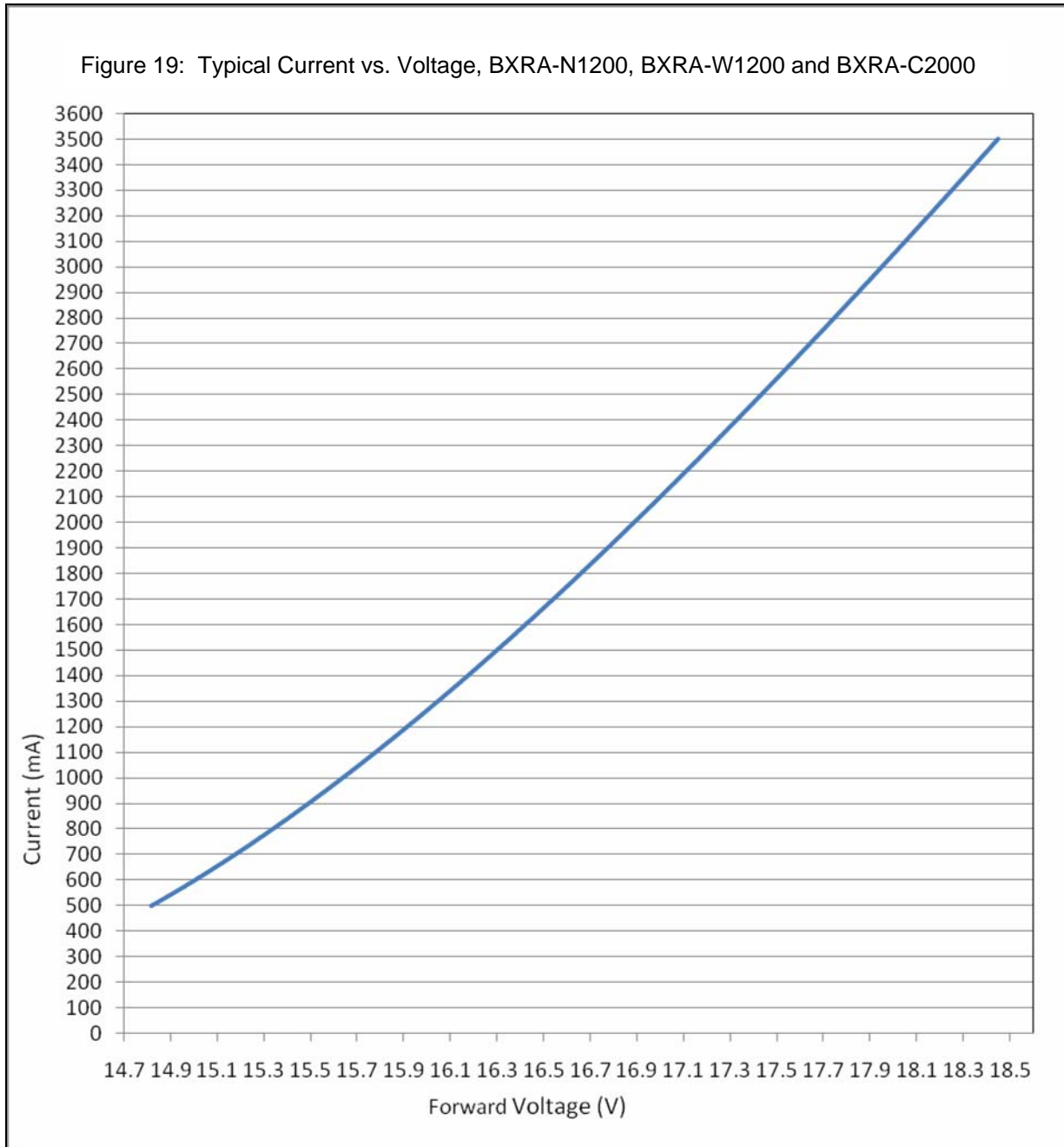

## Current Derating Curves

The graphs below illustrate the relationship between the system thermal resistance, drive current, and ambient temperature. Please note that absolute maximum ratings requirements, including that of maximum case temperature, must be adhered to in the system design. The thermal resistance values indicated in figures 20-29 are total system values (junction to ambient) including the thermal resistance of the LED Array. Individual LED Array thermal resistance values are listed in table 3.

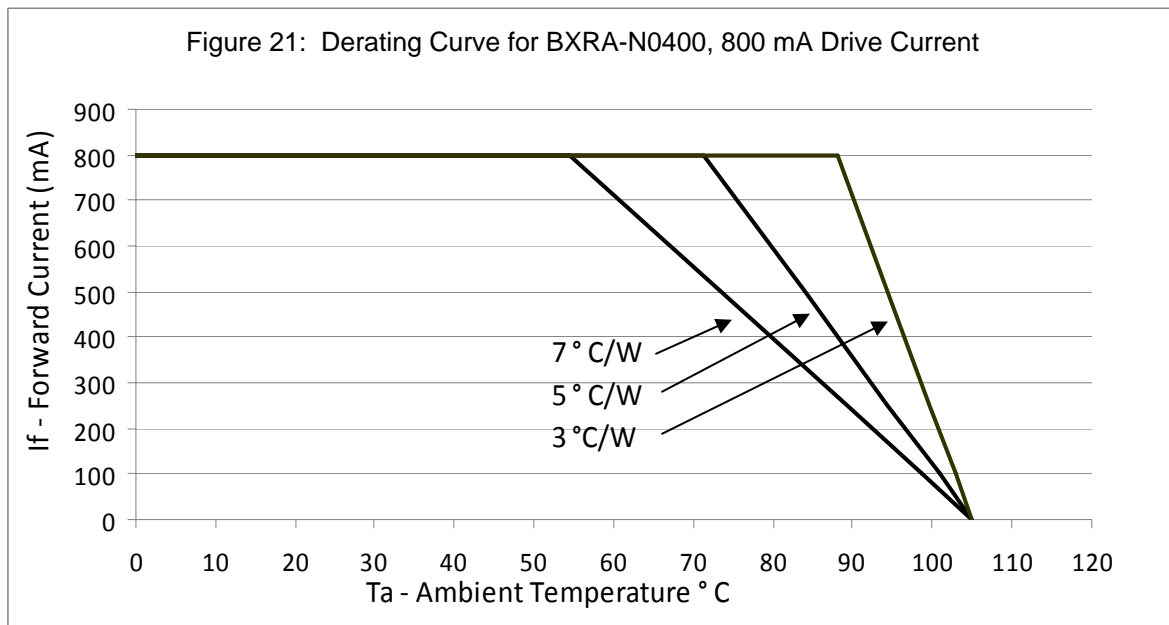
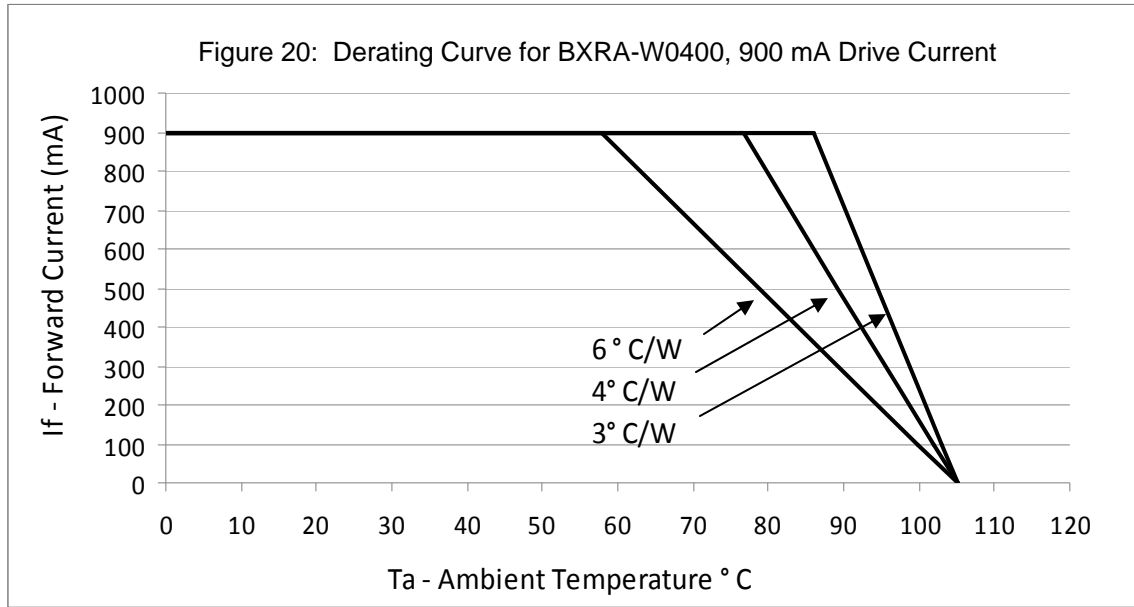

## Current Derating Curves (continued)

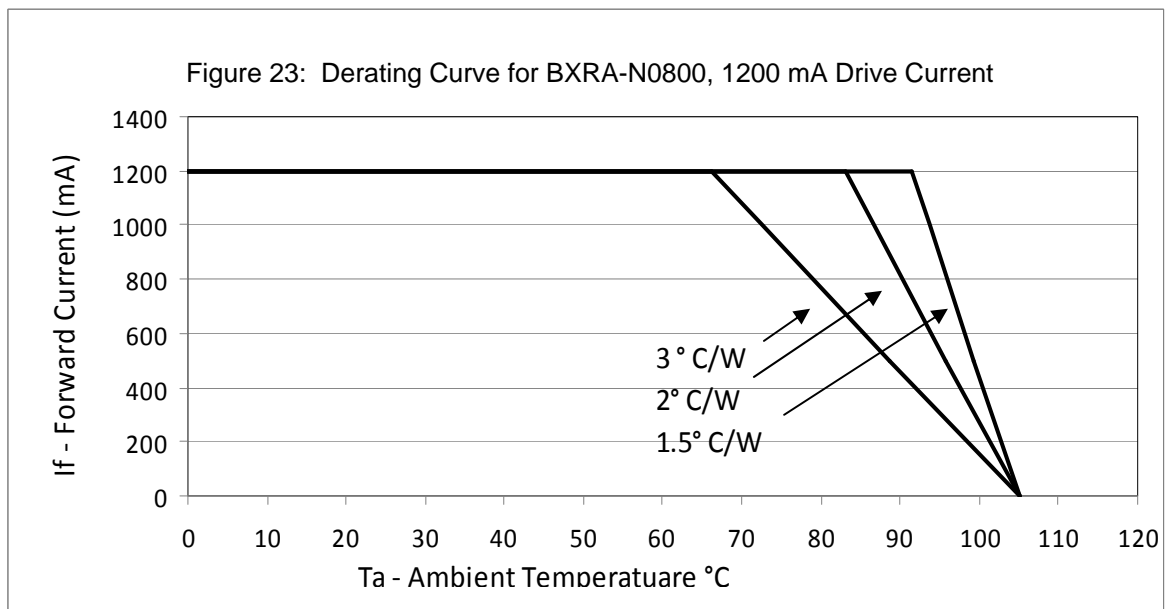
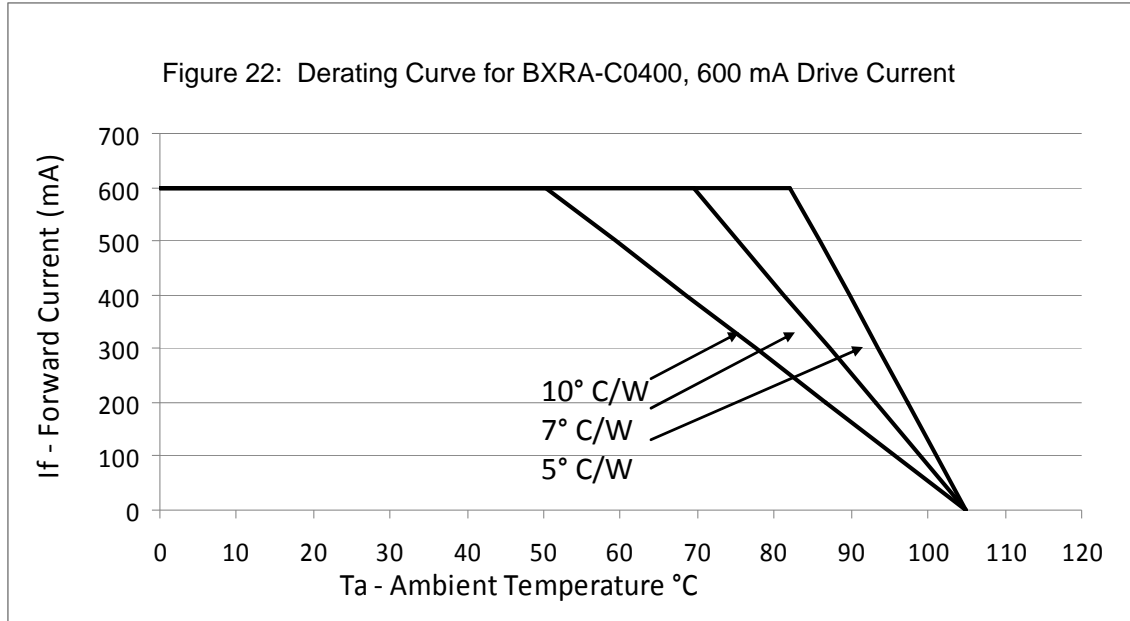

Current Derating Curves (continued)

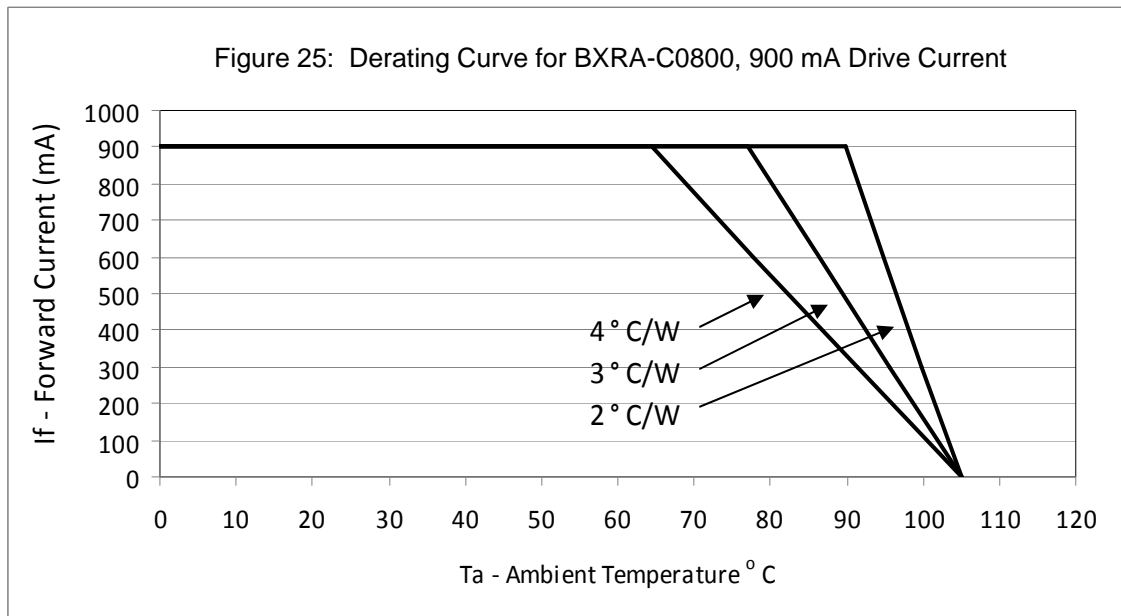
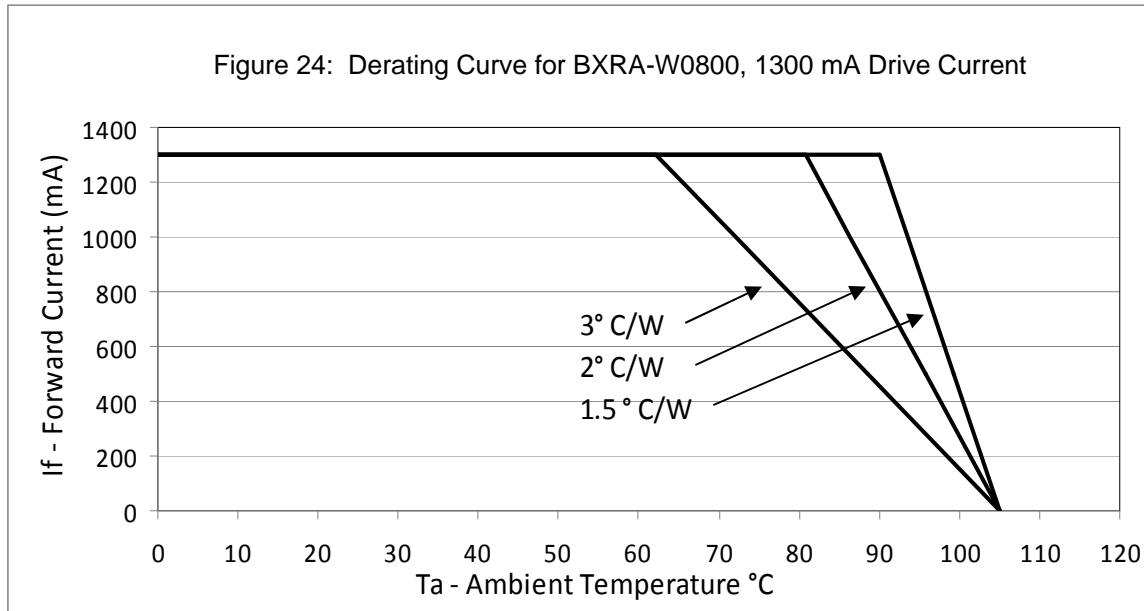

Current Derating Curves (continued)

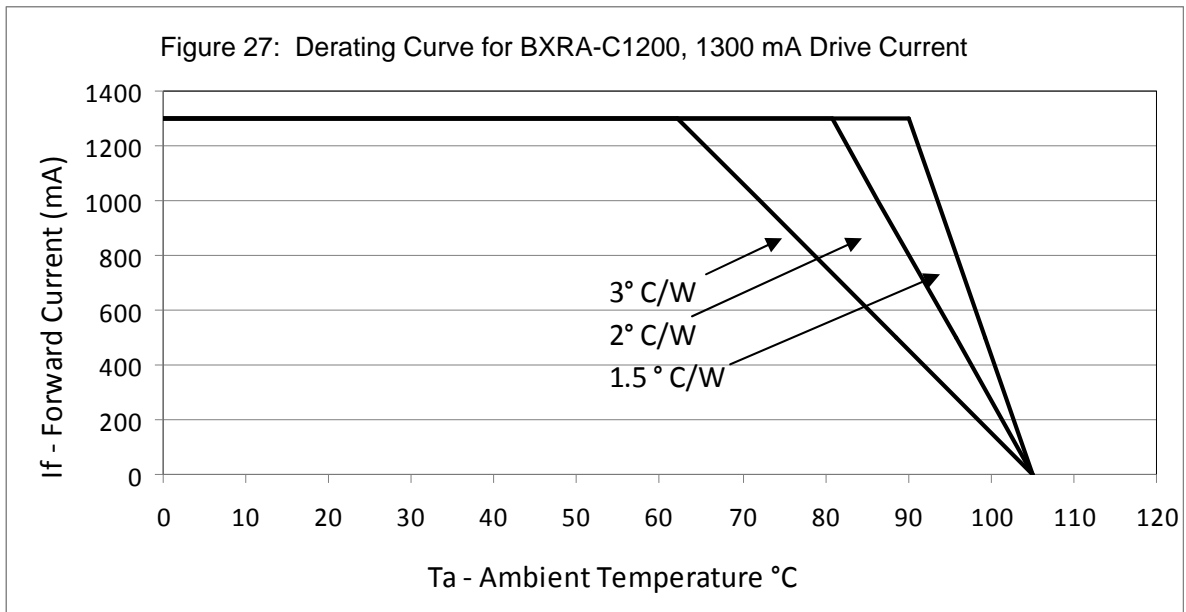
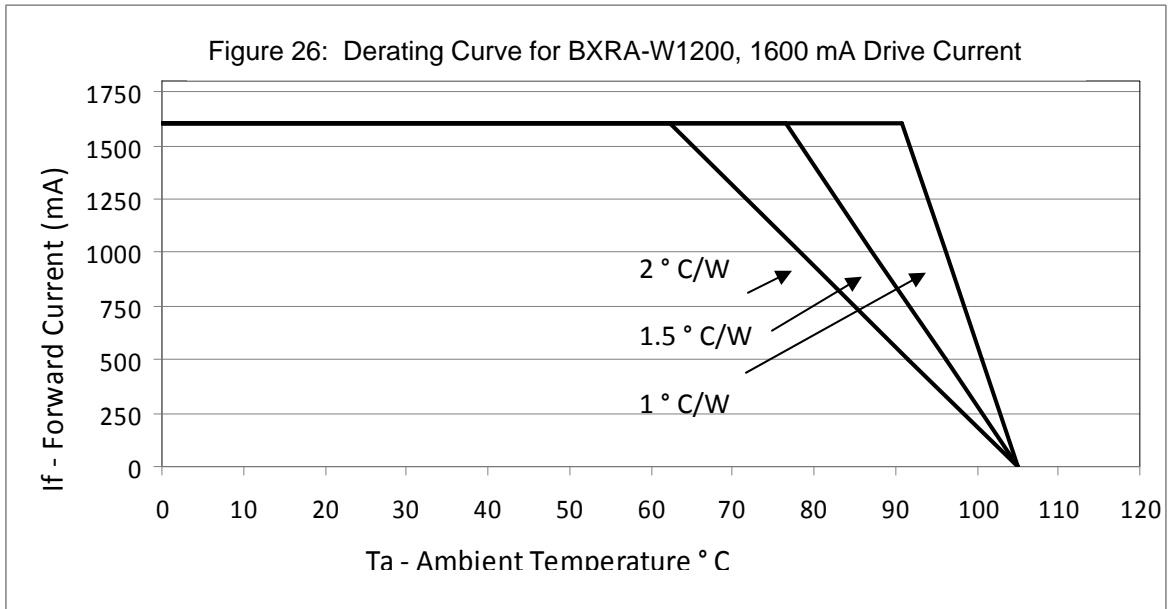



## Current Derating Curves (continued)

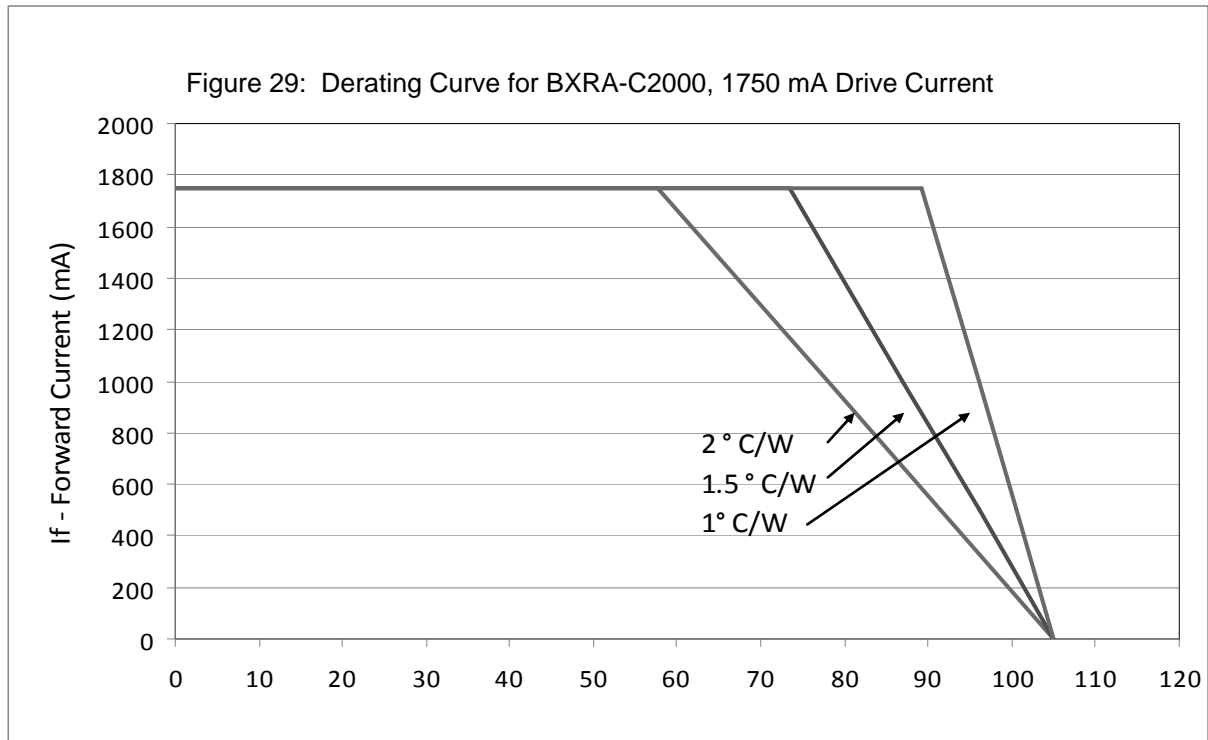
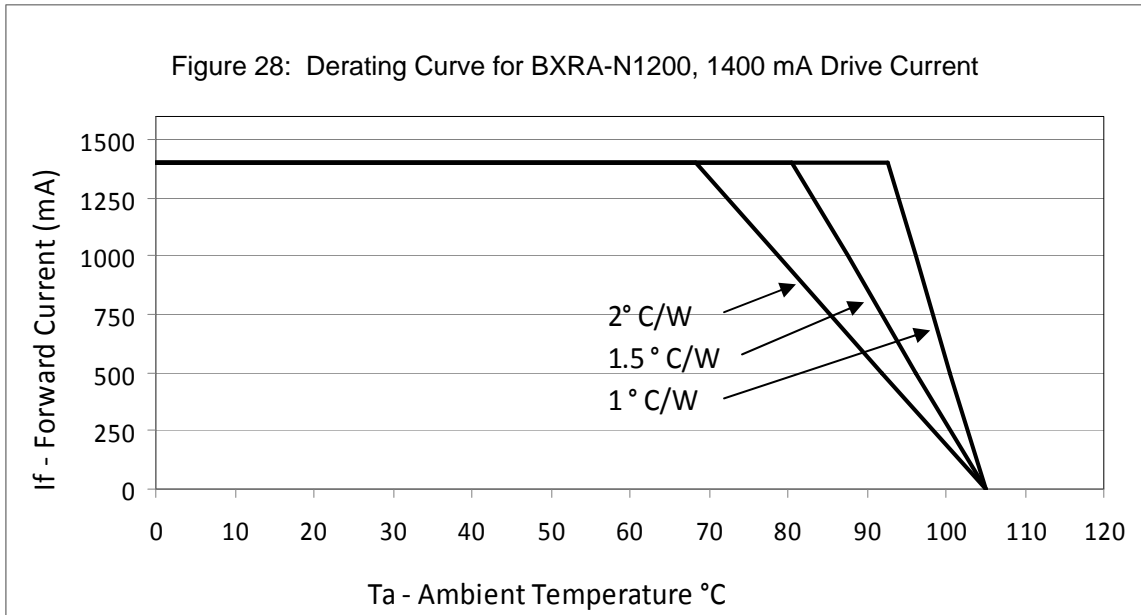

---

## Product Binning

Typical manufacturing processes of semiconductor products result in a variation in performance surrounding the typical data sheet values. In order to minimize variation in the end product of application, Bridgelux bins its LED Arrays for luminous flux and color.

Bridgelux LED Arrays are labeled using a 4-digit alphanumeric bin code. This bin code is printed on the back of each LED in the following format:

A B C D

Where:

- A – designates flux bin (P, Q, R etc.)
- B C – designates color bin (P3, P4, Q3, etc.)
- D – reserved for future product designations,

All product packaged within a single tube are of the same flux and color bin combination (or bin code). Using these codes it is possible to determine the best product utilization to deliver the consistency required in a given application.

## Luminous Flux Binning Information

The table below lists the standard photometric luminous flux bins for Bridgelux LED Arrays (tested and binned at the indicated test current). Although several bins are outlined, product availability in a particular gin varies by product and production run. Please contact your Bridgelux sales representative for further information regarding product availability.

Table 6: Luminous Flux Bins

Bin Code	Min	Max
C	360 lm	400 lm
D	400 lm	440 lm
E	440 lm	500 lm
F	500 lm	570 lm
G	570 lm	640 lm
H	640 lm	720 lm
J	720 lm	800 lm

Bin Code	Min	Max
K	800 lm	880 lm
L	880 lm	980 lm
M	980 lm	1090 lm
N	1090 lm	1200 lm
P	1200 lm	1320 lm
Q	1320 lm	1450 lm
R	1450 lm	1600 lm

Bin Code	Min	Max
S	1600 lm	1800 lm
T	1800 lm	2000 lm
U	2000 lm	2200 lm
V	2200 lm	2450 lm
W	2450 lm	2700 lm
X	2700 lm	3000 lm

## Color Binning Information

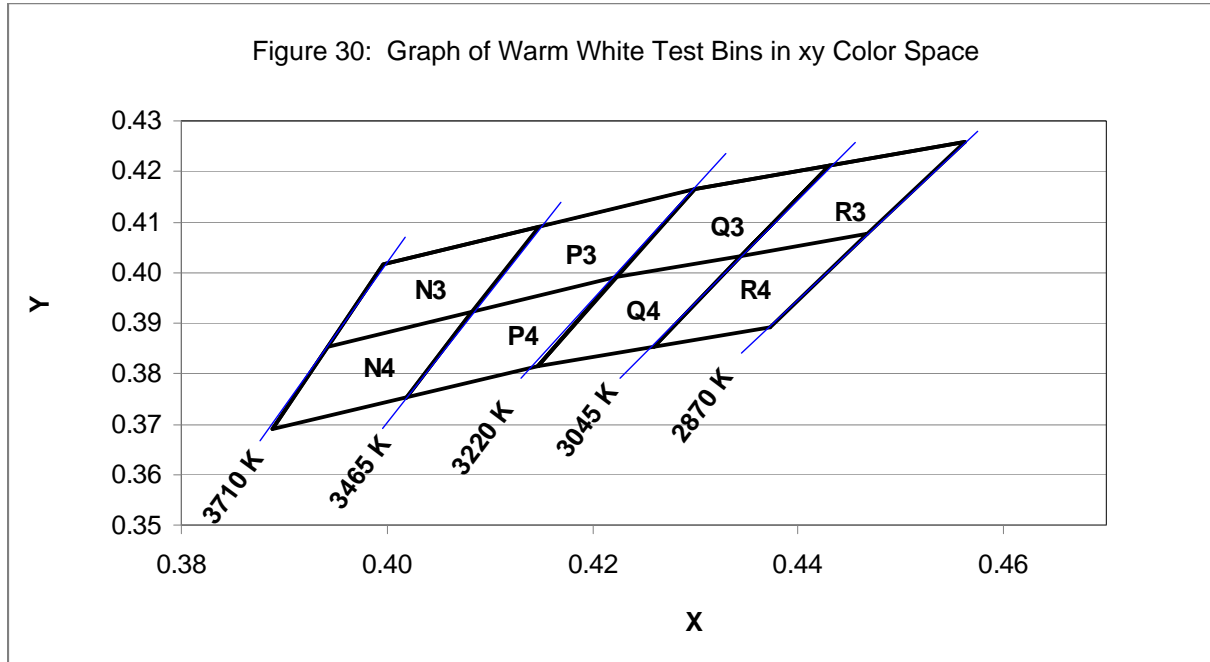

Table 7: Warm White xy Bin Coordinates and Associated Typical CCT

Bin	X	Y	ANSI CCT (K)
N3	0.3943	0.3853	3500
	0.3996	0.4015	
	0.4148	0.4090	
	0.4083	0.3921	
N4	0.3889	0.3690	3500
	0.3943	0.3853	
	0.4083	0.3921	
	0.4018	0.3752	
P3	0.4083	0.3921	3500
	0.4148	0.4090	
	0.4299	0.4165	
	0.4223	0.3990	
P4	0.4018	0.3752	3500
	0.4083	0.3921	
	0.4223	0.3990	
	0.4147	0.3814	
Q3	0.4223	0.3990	3000
	0.4299	0.4165	
	0.4431	0.4213	
	0.4345	0.4033	
Q4	0.4147	0.3814	3000
	0.4223	0.3990	
	0.4345	0.4033	
	0.4260	0.3854	
R3	0.4345	0.4033	3000
	0.4431	0.4213	
	0.4562	0.4260	
	0.4468	0.4077	
R4	0.4260	0.3854	3000
	0.4345	0.4033	
	0.4468	0.4077	
	0.4373	0.3893	

Color Binning Information (continued)

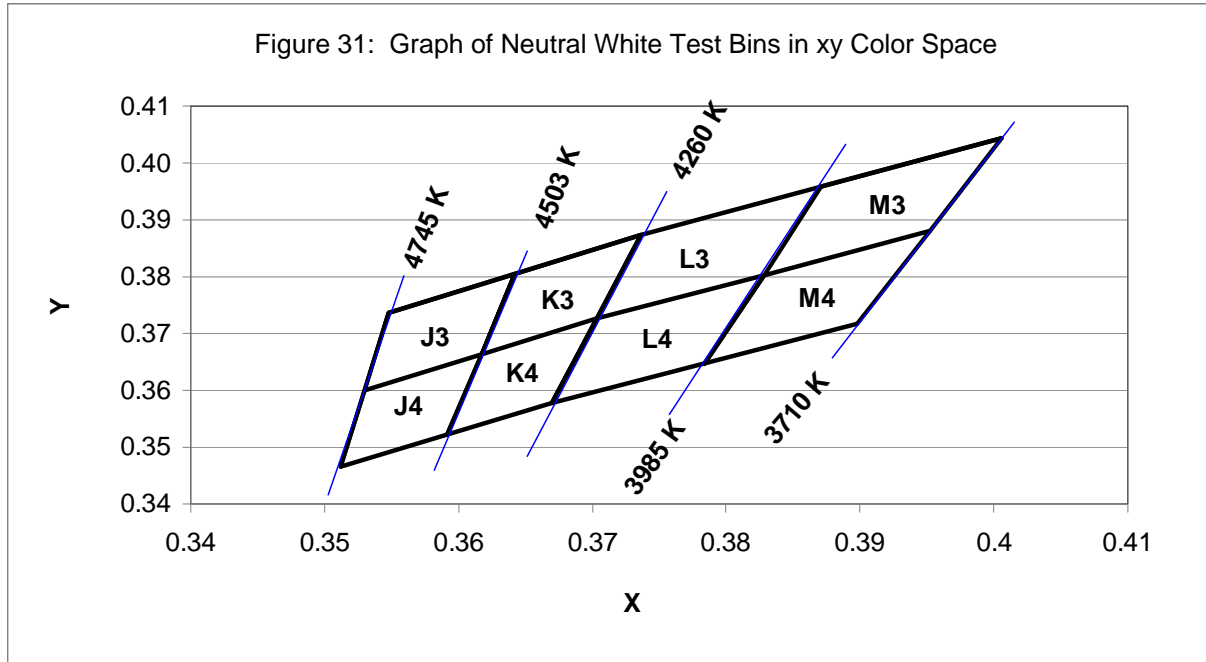

Table 8: Neutral White xy Bin Coordinates and Associated Typical CCT

Bin	X	Y	ANSI CCT (K)	Bin	X	Y	ANSI CCT (K)
J3	0.3530	0.3601	4500	L3	0.3703	0.3726	4000
	0.3548	0.3736			0.3736	0.3874	
	0.3642	0.3805			0.3871	0.3959	
	0.3617	0.3663			0.3828	0.3803	
J4	0.3512	0.3465	4500	L4	0.3670	0.3578	4000
	0.3530	0.3601			0.3703	0.3726	
	0.3617	0.3663			0.3828	0.3803	
	0.3591	0.3522			0.3784	0.3647	
K3	0.3617	0.3663	4500	M3	0.3828	0.3803	4000
	0.3642	0.3805			0.3871	0.3959	
	0.3736	0.3874			0.4006	0.4044	
	0.3703	0.3726			0.3952	0.3880	
K4	0.3591	0.3522	4500	M4	0.3784	0.3647	4000
	0.3617	0.3663			0.3828	0.3803	
	0.3703	0.3726			0.3952	0.3880	
	0.3670	0.3578			0.3898	0.3716	

Color Binning Information (continued)

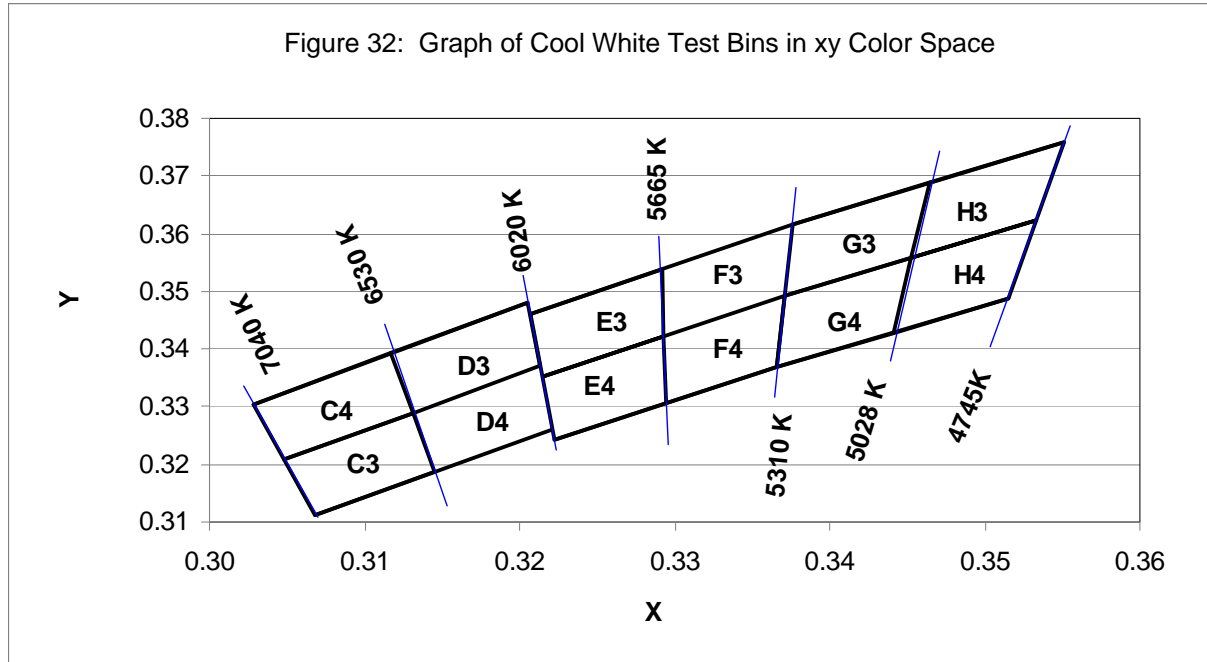

Table 9: Cool White xy Bin Coordinates and Associated Typical CCT

Bin Code	X	Y	ANSI CCT (K)	Bin Code	X	Y	ANSI CCT (K)	Bin Code	X	Y	ANSI CCT (K)
C3	0.3048	0.3209	6500	E3	0.3215	0.3353	5700	G3	0.3376	0.3616	5000
	0.3131	0.3290			0.3293	0.3423			0.3464	0.3688	
	0.3117	0.3393			0.3292	0.3539			0.3452	0.3558	
	0.3028	0.3304			0.3207	0.3462			0.3371	0.3493	
C3	0.3068	0.3113	6500	E3	0.3222	0.3243	5700	G3	0.3371	0.3493	5000
	0.3145	0.3187			0.3294	0.3306			0.3452	0.3558	
	0.3131	0.3290			0.3293	0.3423			0.3441	0.3428	
	0.3048	0.3209			0.3215	0.3353			0.3366	0.3369	
D3	0.3131	0.3290	6500	F3	0.3292	0.3539	5700	H3	0.3464	0.3688	5000
	0.3213	0.3371			0.3293	0.3423			0.3551	0.3760	
	0.3205	0.3481			0.3371	0.3493			0.3533	0.3624	
	0.3117	0.3393			0.3376	0.3616			0.3452	0.3558	
D4	0.3145	0.3187	6500	F4	0.3294	0.3306	5700	H4	0.3452	0.3558	5000
	0.3221	0.3261			0.3366	0.3369			0.3533	0.3624	
	0.3213	0.3371			0.3371	0.3493			0.3515	0.3487	
	0.3131	0.3290			0.3293	0.3423			0.3441	0.3428	

---

## Mechanical Assembly and Handling

Recommended assembly is illustrated below.

When handling parts, please do not apply stress to the resin and avoid any contact on the resin area (see drawing).

Product should be firmly secured onto appropriate heat sink by fastening M2.5 or #4 screws on both sides of the product (see drawing). Bridgelux recommends the use of hard non-electrically conductive flat washers with lock washers. Refer to Application Note AN11 for more details.

A thin layer of thermal grease should be applied to the bottom surface of the array, between the bottom of the array and the heat sink. All air gaps and voids between the heat sink and array should be eliminated. Ensure that sufficient thermal grease is used to cover the entire bottom surface of the array, but not so much that the thermal grease creeps up to the top of the array.

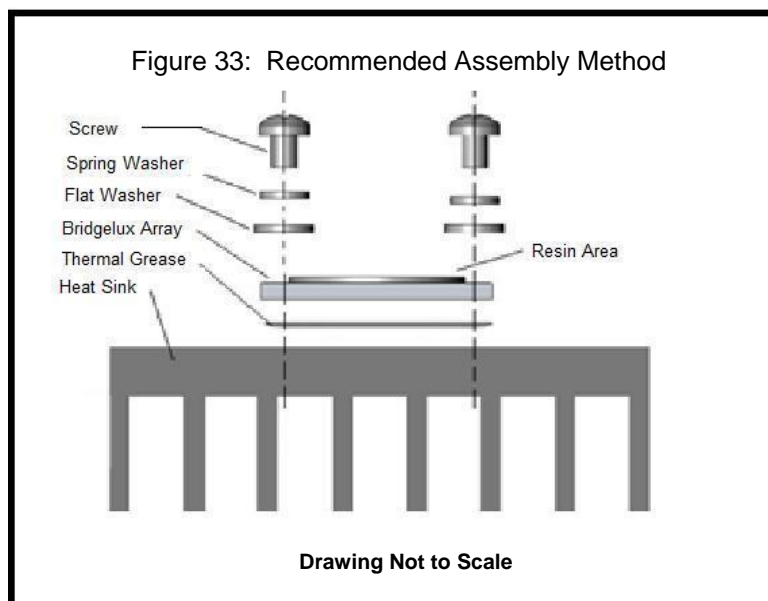

For the Hexagonal star products, preferred locations for screw mounting are indicated in the figure below.

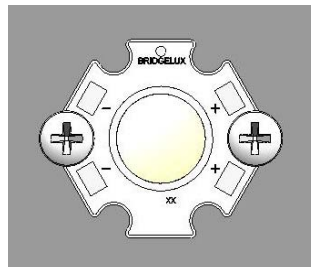

Figure 34: Recommended Mounting Locations for Hexagonal Star Products

---

## Product Packaging and Labeling

All Bridgelux LED Array products are 100% tested, binned and labeled. Products are labeled by printing pertinent information on the back side of the array.

The following format is used for labeling the Bridgelux LED Arrays:

A B C D  
B X R A – x x x x x  
E F G H J – W W Y Y

Where:

A B C D – designates the bin code (LQ30, etc.)

x x x x x – designates the base part number (W0800, etc.)

E F G H J – designates the production lot code (12345, etc.)

W W Y Y – designates the date code (production week and production year, 0509, etc.)

Individual Bridgelux LED Arrays are packaged in tubes for shipment. All product packaged within a single tube are of the same flux and color bin combination (or bin code). Each tube is labeled with the information required for effective inventory management. An example of the tube label is included below:

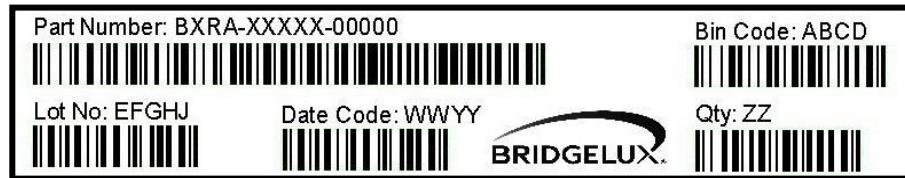

Figure 35: Tube Label Example

Where:

A B C D – designates the bin code (LQ30, etc.)

x x x x x – designates the base part number (W0800, etc.)

E F G H J – designates the production lot code (12345, etc.)

W W Y Y – designates the date code (production week and production year, 0509, etc.)

Z Z – designates the quantity (25 products per tube for hexagonal stars, 20 for rectangles)

---

## Product Packaging and Labeling (continued)

Tubes of Bridgelux LED Arrays are packaged in bags prior to loading into boxes for shipment. One tube is loaded per bag, resulting in an SPI of 25 for hexagonal star products and 20 for rectangular product configurations. All products packaged within a single bag are of the same flux and color bin combination (or bin code). Each bag is labeled with the information required for effective inventory management. An example of the tube label is included below.

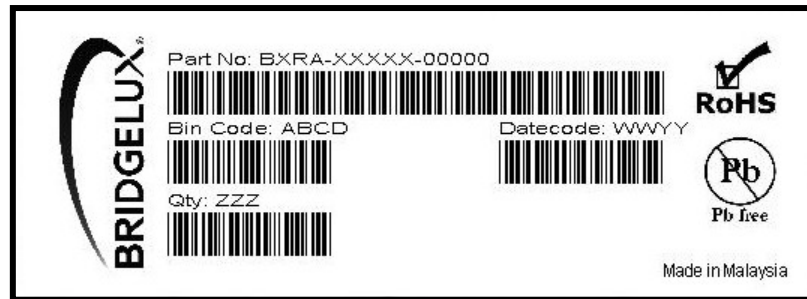

Figure 36: Bag Label Example

Where:

A B C D – designates the bin code (LQ30, etc.)

x x x x x – designates the base part number (W0800, etc.)

W W Y Y – designates the date code (production week and production year, 0509, etc.)

Z Z Z – designates the quantity (50 products per tube for hexagonal stars, 40 for rectangles)



## Packaging Tube Design

Figure 37: Tube Design for Hexagonal Star Products

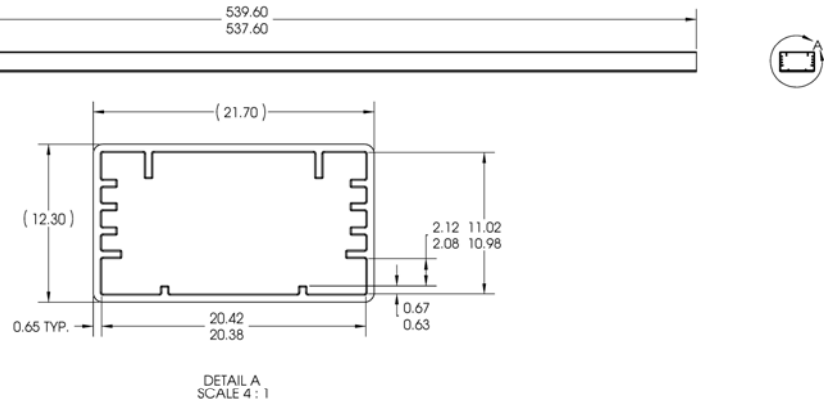
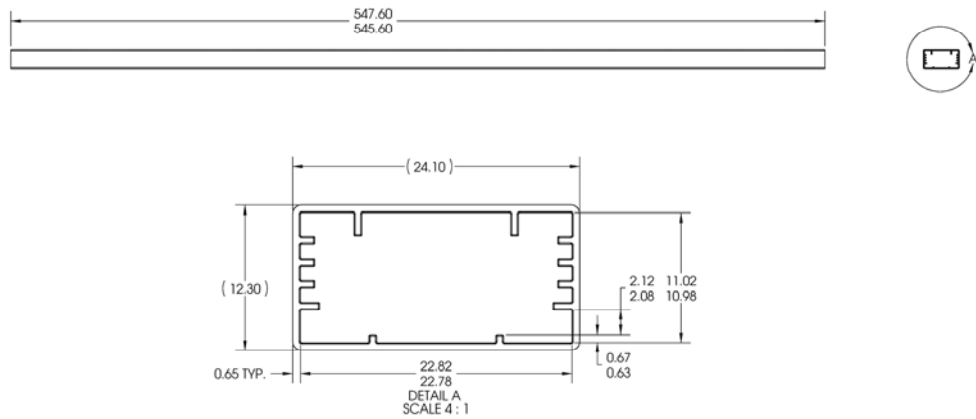

Figure 38: Tube Design for Rectangular Array Products



Notes for Figures 37 and 38:

1. Drawings are not to scale.
2. Drawing dimensions are in millimeters.

---

## About Bridgelux

Focused on bringing innovation to light, Bridgelux is a leading provider of high-power, cost-effective and energy-efficient light-emitting diode (LED) solutions. The company's proprietary epitaxy technology, innovative chip designs and leading-edge LED packaging technology have enabled the company to develop advanced solid-state lighting (SSL) products that offer superior quality, are lower in cost and environmentally friendly—all without compromising performance. In addition to LED chips, the company delivers a range of SSL light sources that customers can easily integrate into a variety of lighting applications that will open up new markets in solid-state lighting. Founded in 2002, Bridgelux is headquartered in Sunnyvale, California. For more information about the company, please visit [www.bridgelux.com](http://www.bridgelux.com)

© 2009 Bridgelux, Inc. All rights reserved. Product specifications are subject to change without notice

